



INTELLICENTER™ CONTROL SYSTEM INDOOR CONTROL PANEL



INSTALLATION GUIDE

IMPORTANT SAFETY INSTRUCTIONS
READ AND FOLLOW ALL INSTRUCTIONS
SAVE THESE INSTRUCTIONS

CUSTOMER SERVICE / TECHNICAL SUPPORT

Customer Service
 8 AM to 8 PM
 Phone: (800) 831-7133
 Fax: (800) 284-4151
 Visit www.pentair.com

Technical Support
 Sanford, North Carolina (8 AM to 8 PM ET)
 Phone: (919) 566-8000
 Fax: (919) 566-8920
 Moorpark, California (8 AM to 5 PM PT)
 Phone: (805) 553-5000
 Fax: (805) 553-5515

Contents

IMPORTANT WARNING AND SAFETY INSTRUCTIONS	i-iv
Indoor Control Panel Installation Overview	1
Features	1
Indoor Control Panel Installation	2
Mounting the Indoor Control Panel	3
Connecting the Communication Cable to the Indoor Control Panel.....	4
USB Port	4
RESET Button.....	4
Connecting the Indoor Control Panel Communication Cable to the Personality Circuit Board.....	5
Configuring the Indoor Control Panel.....	6
Using the USB Port to Import/Export a System Configuration.....	7
Indoor Control Panel Firmware Update.....	8
IntelliCenter Control System Menu	9

IMPORTANT WARNING AND SAFETY INSTRUCTIONS

READ AND FOLLOW ALL WARNING AND SAFETY INSTRUCTIONS

⚠ DANGER SERIOUS BODILY INJURY OR DEATH CAN RESULT IF THIS PRODUCT IS NOT INSTALLED AND USED CORRECTLY.

⚠ DANGER INSTALLERS, POOL OPERATORS AND POOL OWNERS MUST READ THESE WARNINGS AND ALL INSTRUCTIONS BEFORE USING THIS PRODUCT. This Guide provides installation and operation instructions for the product. Consult Pentair Water Pool and Spa, Inc. (“Pentair”) with any questions regarding this product.

⚠ WARNING This product is intended for use in swimming pool applications only.

⚠ WARNING Most states and local codes regulate the construction, installation, and operation of public pools and spas, and the construction of residential pools and spas. It is important to comply with these codes, many of which directly regulate the installation and use of this product. Consult your local building and health codes for more information.



This guide provides installation and operation instructions for the IntelliCenter™ Control System Indoor Control Panel. Consult Pentair Water Pool and Spa, Inc. with any questions regarding this equipment! (see “Customer Service/Technical Support”, page ii).



Attention Installer: This guide contains important information about the installation, operation and safe usage of this product.

Attention User: This manual contains important information that will help you in operating and maintaining this filter. Please save it for future reference.

⚠ WARNING **Attention User:** This Guide contains important information that will help you in operating and maintaining this product. Please retain it for future reference. Read the entire Installation Guide and all related warning labels before installing this product or attempting to use, service or adjust the IntelliCenter Control System or heater. Read the operating instructions and warnings for all equipment in the pool circulating system before operating. Failure to follow safety warnings and instructions can result in severe injury, death, or property damage. Call (800) 831-7133 for additional free copies of this Guide or replacement safety labels.

This product is designed and manufactured for safe and reliable service when installed, operated and maintained according to the information and installation codes referred to in this Guide.



This is a safety alert symbol. When you see this symbol in this manual or on the product, look for one of the following signal words; **DANGER, WARNING, CAUTION** and **NOTICE** and comply with the information. Be alert to the potential hazard. Ensure to read and comply with all of the warnings and cautions in this manual.

NOTICE



⚠ DANGER



Risk of Electrical Shock or Electrocution!

- Always disconnect power at the circuit breaker before servicing the load center. Improper installation can create an electrical shock hazard that can result in death or serious injury.

This product must be installed by a licensed or certified electrician or a qualified pool professional in accordance with the current National Electrical Code (NEC), NFPA 70 or the Canadian Electrical Code (CEC), CSA C22.1. All applicable local installation codes and ordinances must also be adhered to. Improper installation will create an electrical hazard which could result in death or serious injury to pool users, installers or others due to electrical shock, and may also cause damage to

property. Always disconnect the power to the pool light at the circuit breaker before servicing the light. Failure to do so could result in death or serious injury to serviceman, pool users or others due to electrical shock.

IMPORTANT WARNING AND SAFETY INSTRUCTIONS

⚠ DANGER



Water temperature in excess of 100° F (37.7° C) may be hazardous to your health. Prolonged immersion in hot water may induce hyperthermia. Hyperthermia occurs when the internal temperature of the body reaches a level several degrees above normal body temperature of 98.6° F (37° C.). Effects of hyperthermia include: (1) Unawareness of impending danger. (2) Failure to perceive heat. (3) Failure to recognize the need to leave the spa. (4) Physical inability to exit the spa. (5) Fetal damage in pregnant women. (6) Unconsciousness resulting in danger of drowning. The use of alcohol, drugs, or medication can greatly increase the risk of fatal hyperthermia in hot tubs and spas.

⚠ WARNING

A pool or spa pump must be installed by a qualified pool and spa service professional in accordance with the current National Electrical Code and all applicable local codes and ordinances. Improper installation may create an electrical hazard which could result in death or serious injury to pool users, installers, or others due to electrical shock, and may also cause damage to property.

⚠ WARNING

The use of alcohol, drugs, or medication can greatly increase the risk of fatal hyperthermia in hot tubs and spas. This product is intended to control heaters with built-in high limit circuits **ONLY**. Failure to do so may cause property damage or personal injury.

⚠ WARNING

Do not use this product to control an automatic pool cover. Swimmers may become entrapped underneath the cover.

⚠ WARNING

For units intended for use in other than single-family dwellings, a clearly labeled emergency switch shall be provided as part of the installation. The switch shall be readily accessible to the occupants and shall be installed at least five (5) feet (1.52 m) away, adjacent to, and within sight of, the unit.

⚠ WARNING

Except for listed spa-side remote controls, install a minimum of five (5) feet (1.52 m) from the inside wall of the pool and spa.

⚠ WARNING

The electrical supply for this product must include a suitably rated switch or circuit breaker to open all ungrounded supply conductors to comply with the current National Electrical Code (NEC), NFPA 70 or the Canadian Electrical Code (CEC), CSA C22.1. All applicable local installation codes and ordinances must also be adhered to. The disconnecting means must be readily accessible to the tub occupant but installed at least five 5ft. (1.52 m), (Canada 3 m (9.75 ft) from the inside wall of the pool.

⚠ WARNING

Use only copper supply conductor's rated for 60C/75C sized based on ampacity to support all loads (refer to NEC tables). Load center input supply to be protected by 150 Amp Maximum, 240 VAC Main Circuit Breaker.

For information about the Virginia Graeme Baker Pool and Spa Safety Act, contact the Consumer Product Safety Commission at (301) 504-7908 or visit www.cpsc.gov.

NOTE: Always turn off all power to the pool pump before installing the cover or working on any suction outlet.

Two Speed Pump Controls Notice (Title 20 Compliance)

Please read the following important Safety Instructions - When using two-speed pumps manufactured on or after January 1, 2008, the pump's default circulation speed **MUST** be set to the **LOWEST SPEED**, with a high speed override capability being for a temporary period not to exceed one normal cycle, or two hours, whichever is less.

IMPORTANT WARNING AND SAFETY INSTRUCTIONS

General Installation Information

1. All work must be performed by a licensed electrician, and must conform to all national, state, and local codes.
2. Install to provide drainage of compartment for electrical components.
3. If this system is used to control underwater lighting fixtures, a ground-fault interrupter (GFCI) must be provided for these fixtures. Conductors on the load side of the ground-fault circuit-interrupter shall not occupy conduit, junction boxes or enclosures containing other conductors unless such conductors are also protected by a ground-fault circuit-interrupter. Refer to local codes for details.
4. A terminal bar stamped  is located inside the supply terminal box. To reduce the risk of electric shock, this terminal must be connected to the grounding means provided in the electric supply service panel with a continuous copper wire equivalent in size to the circuit conductors supplying this equipment (no smaller than 12 AWG or 3.3 mm). The bonding lug(s) provided on this unit are intended to connect a minimum of one No. 8 AWG for US installation and two No. 6 AWG for Canadian installations solid copper conductor between this unit and any metal equipment, metal enclosures or electrical equipment, metal water pipe, or conduit within 5 feet (1.5 m) of the unit.
5. The electrical supply for this product must include a suitably rated switch or circuit breaker to open all ungrounded supply conductors to comply with in accordance with the current National Electrical Code (NEC), NFPA 70 or the Canadian Electrical Code (CEC), CSA C22.1. All applicable local installation codes and ordinances must also be adhered to. The disconnecting means must be readily accessible to the tub occupant but installed at least 10 ft. (3.05 m) from the inside wall of the pool.
6. GAS HEATER: This control system is designed to supply high voltage (120 VAC / 240 VAC) to a gas heater and override the thermostat in the heater's control circuit. This control system is intended to control gas heaters with a high temperature limit switch(s) safety circuit.

Blank Page

IntelliCenter™ Automation System for Pool and Spa Indoor Control Panel Installation Overview

Welcome! This guide describes how to install the IntelliCenter System Indoor Control Panel. Please take time to read through this guide to familiarize yourself with the IntelliCenter System Indoor control Panel installation steps.

The IntelliCenter System Indoor Control Panel provided one touch controls for your pool, spa, lights and other functions from inside your home or a sheltered location. Select a convenient wall location inside your house or other weather-protected location for mounting the control panel.

Features

- 4" x 2.5" capacitive touch sensitive color touch screen with finger tap navigation, 1280 x 720 resolution
- Day Time and Night Time color screen modes
- Multifunction Schedules/Programs
- Adjustable schedule timer for easy system scheduling
- 100 Schedules/Programs
- Adjustable schedule timer for easy system scheduling
- Wireless Control Panel "Deep Sleep" extend battery life feature
- 64 Feature Circuits: Allow additional speeds on a variable speed pump or an actuator to be assigned without using an existing auxiliary circuit.
- 16 Groups: Assign groups of lighting, heaters, pumps circuits that can be controlled by a single button.
- Supports up to 16 IntelliFlo® VF and VS Pumps
- Supports up to four SpaCommand® and iS10 Spa Side Remotes, and 2 iS4 and QuickTouch® II Wireless Spa Side Remotes
- Supports IntelliBrite® LED Color lights
- Valves: Intake/Return plus A and B valve circuits. Expandable up to 13 valves.
- 20 custom circuit naming - 92 Pre-installed names
- Indoor Control Panel, Wireless Hand-Held Remote, Outdoor Control Panel
- IntelliChlor® and iChlor® Salt Chlorine Generator compatibility
- 40 Auxiliary circuits (includes three Expansion Panels)
- 32 Feature circuits
- Spa, Manual Heat Function
- Supports two separate bodies of water using model i10D Personality Card
- System Reboot from touch screen control panels
- Spa Side Control Enable/Disable
- Solar Heating Option/Support
- 16 Heat Pump Support: RS485 Support, Heat Pump Cooling Support.
- Safety and Functional Delay(s) and Cancel Systems Delays
- Real Time Clock
- Assignable Circuit Names and Custom Circuit Names
- Special Circuit Functions
- Two Speed Pump Support
- English/Metric Support
- Sensor Calibration
- Passcode Protection
- USB port for use with a standard flash drive. Save the complete system's configuration, upgrade the system's firmware.

IntelliCenter™ Automation System For Pool and Spa Indoor Control Panel Installation



SWITCH OFF AC POWER TO THE INTELLICENTER SYSTEM LOAD CENTER BEFORE MAKING ANY CONNECTIONS.



BEFORE REMOVING THE HIGH VOLTAGE COVER PANEL FROM THE LOAD CENTER OR POWER CENTER ENCLOSURE SWITCH OFF THE POWER AT THE HOUSE MAIN CIRCUIT BREAKER BOX.

1. Switch OFF AC power to the enclosure at the main house panel circuit breaker.
 2. Unlatch the front door latch and open the front door. Remove the two retaining screws from the High Voltage Cover Panel and remove the panel.
 3. Loosen the two retaining screws securing from the top edge of the Outdoor Control Panel. Fold down the Outdoor Control Panel to access the circuit board sockets connectors for the electrical connections.
 4. FROM THE INDOOR CONTROL PANEL LOCATION: Route the four conductor RS-485 connection cable from the Indoor Control Panel location into the Load Center lower plastic grommet, up through the **low voltage raceway** to the system circuit board.
 5. Connect the communication cable conductors to the **COM PORT (J15 or J16)** connector. See page 5.
 7. **After Connecting the RS-485 cable to the Indoor Control Panel (pages 3-6):** When finished connecting the communication cable to the RS-485 connector on the main circuit board, close the hinged control panel and secure it with the two retaining screws. Reinstall the High Voltage Panel: Insert the panel's three tabs into the lower slots on the enclosure. Secure the panel with the two (2) retaining screws.
- Close the front door and secure with the latch.

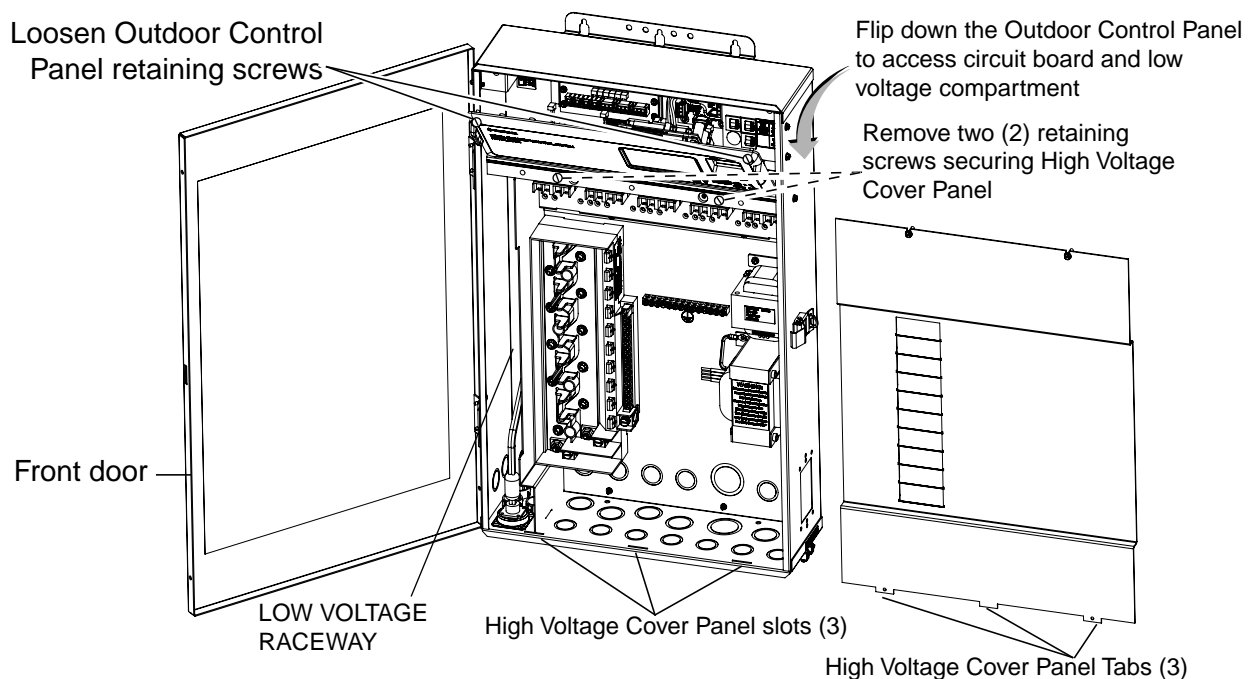

IntelliCenter Automation System Load Center (front view)
(High Voltage Cover Panel removed)

Mounting the IntelliCenter™ Automation System For Pool and Spa Indoor Control Panel

Select a convenient wall location inside your the house or other weather-protected location for mounting the control panel.

To mount and connect the RS-485 communication cable to the IntelliCenter Automation System Indoor Control Panel:

1. Remove the Indoor Control Panel front cover from the back plate. Unsnap the bottom edge of the front of the Indoor Control Panel cover from the back plate. See illustration on next page.
2. Use the cutout-backplate template (shown below), or the actual backplate against the mounting surface so that it is oriented in an upright position. Use a pencil to mark the two (or four) screw locations on the mounting surface for the mounting holes. Drill a minimum of two $\frac{3}{16}$ " diameter holes into the mounting surface. If the screws are not being screwed into studs, drill $\frac{3}{16}$ " holes and insert the wall anchors (provided) as required. Use either of the two vertical or horizontal backplate mounting. For measurements, see backplate template shown below.

Continue to page 4.

Cut a 1" square (or round) hole in mounting surface for communication cable

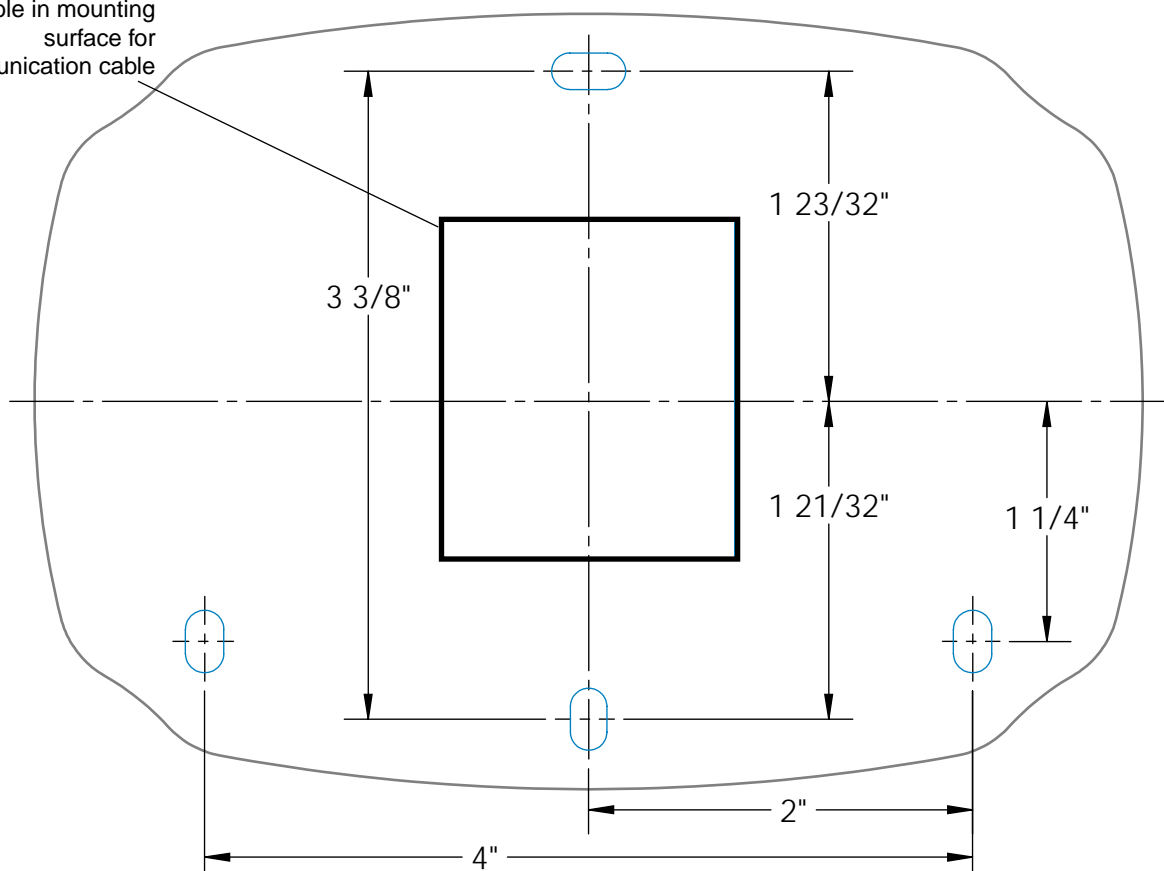

Indoor Control Panel (Backplate Template)

Connecting the Communication Cable to the Indoor Control Panel

3. Mount the Indoor Control Panel backplate on the mounting surface. Align the backplate screw holes with the backplate screw holes and secure the backplate with the screws (see illustration on previous page).
4. At the Indoor Control Panel, strip the leads of the communication cable wires back $\frac{1}{4}$ in. Insert the wires into the connector screw terminals (provided in the kit). Using a small flat-blade screwdriver, secure the wires with the terminal screws. Make sure to match the color-coding of the wires: GND = Black, Green = -DT, Yellow = +DT, and Red = +15. Connect the screw terminal connector onto the transceiver circuit board. The preferred wire color scheme is: Red, Yellow, Green, and Black.
5. Mount the Indoor Control Panel cover over backplate and snap in place to secure.
6. Run a UL approved four conductor cable (22 AWG) from the Indoor Control Panel to the Load Center. **NOTE: Use 18 AWG conductor cable for distances longer than 200 ft.**

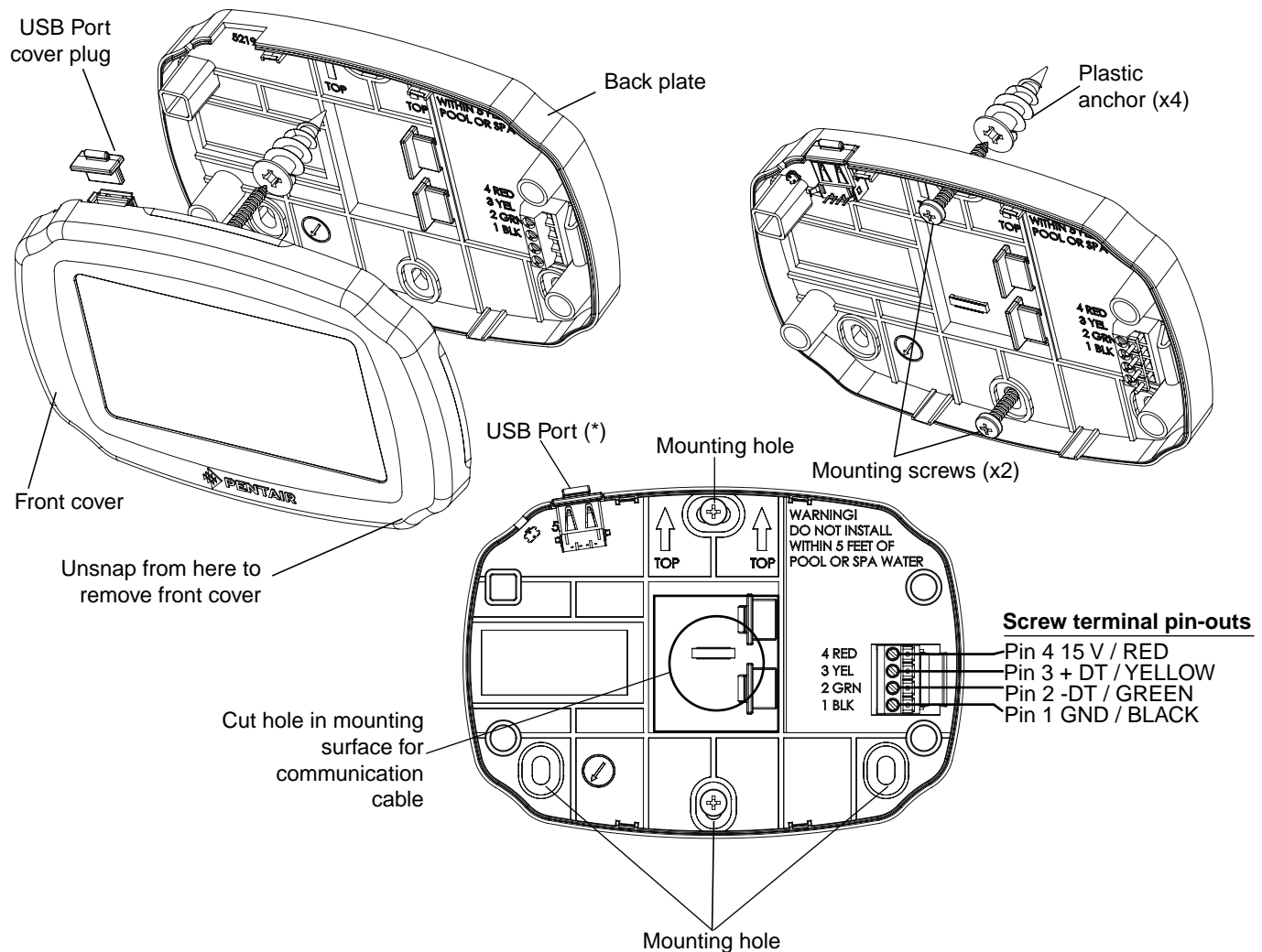

Note: (*) Use the USB port to upgrade the IntelliCenter Control System firmware. See page 7.

Configuring the Indoor Control Panel

The following information describes how to configure the Indoor Control Panel from the Indoor Control Panel Home screen. For more detailed information refer to the IntelliCenter™ Automation System User's Guide (P/N 522561) and the IntelliCenter Automation System Installation Guide (P/N 522989.)

To configure the IntelliCenter System Indoor Control Panel:

1. Power to the IntelliCenter System Indoor Control Panel (Home screen displayed) is applied from the IntelliCenter System Load Center Outdoor Control Panel. Verify that the IntelliCenter System Load Center is powered on. If not, switch on the main circuit breakers to apply power to the Load Center.
2. From the Home screen on the Indoor Control Panel, tap **Settings > Advanced System Configuration > Installation Setup > Body Configuration**.
3. Tap Indoor Control Panel to enable the Indoor Control Panel. Follow the screen prompts to configure the Indoor Control Panel. When finished save the system configuration. The Indoor Control Panel is now ready for operations.

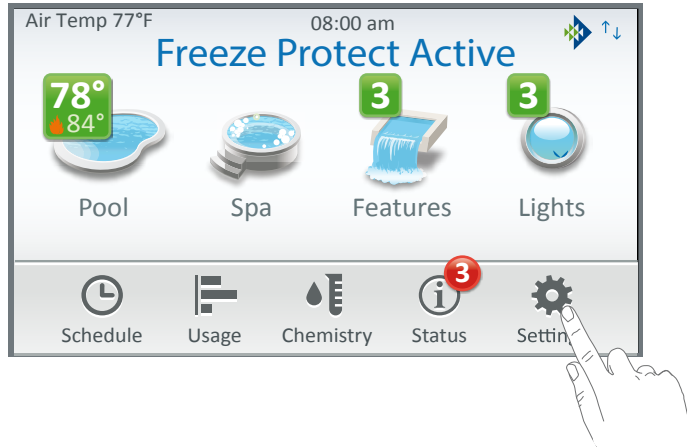

Using the USB Port to Import/Export a System Configuration

The following information describes how to import or export the IntelliCenter™ Automation System For Pool and Spa configuration using a USB device. For more detailed information refer to the IntelliCenter Automation System User's Guide (P/N 522561).

Import System Configuration: Use this feature to import a system configuration.



To access the Import/Export screen from the Home screen, tap Settings > Advanced System Configuration > Import/Export.

Note: Once a USB device is detected, a USB icon is displayed on the upper right corner of the screen.

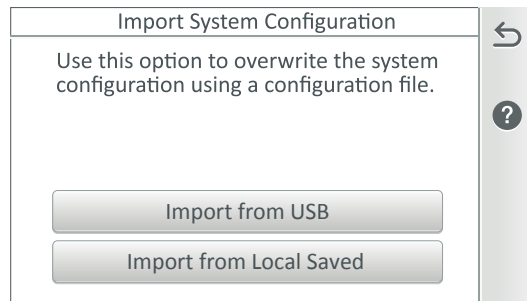

Import System Configuration: Import from USB, Import from local Saved.:These options will overwrite the system configuration using a configuration file. Navigate to the appropriate folder and select the configuration file (.cfg) to import.

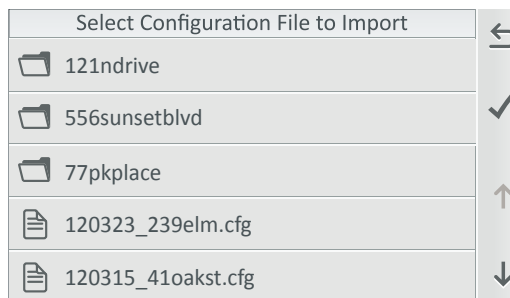

Import for USB: Insert a USB device into the USB Port on the front of the IntelliCenter Automation System Indoor Control Panel. Tap Import from USB and navigate to the system configuration file (.CFG). Follow the on screen instructions to import the system configuration files.

Import to Local: Tap Import from Local and follow the on screen instruction

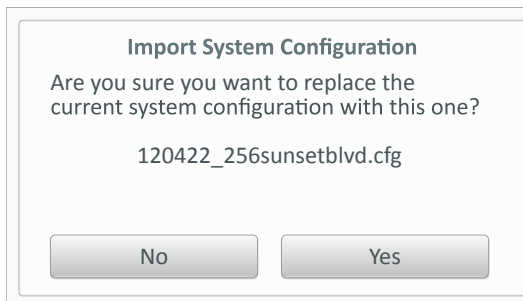
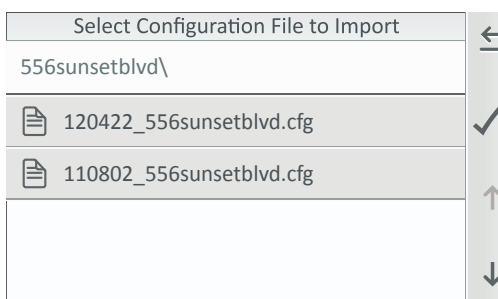

Export System Configuration: Export from USB or local. Use this option to export a system configuration file to a USB device. Select a location for the configuration file and follow the screen prompts.

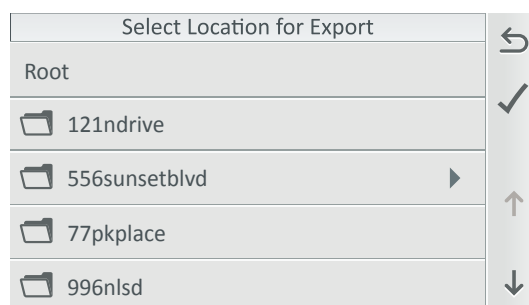

Indoor Control Panel Firmware Update

The Indoor Control Panel current firmware can be updated using the USB port.

Update the Current Indoor Control Panel Firmware:

1. Insert a USB device in the USB port on the IntelliCenter System Outdoor, Indoor Control Panel or the Wireless Remote.
2. From the Home screen on the Wireless Remote. Tap **Settings > Advanced System Configuration > System** to access the System screen.
3. Tap **Firmware Update** to open the Firmware Update screen, then tap **Update From USB**.



Check for Update: Tap this button to check for the latest firmware version. Follow the screen prompts.

Firmware Update: Tap this button to display the Firmware Update screen. This screen displays the current firmware version.

Update from USB: Insert the USB device into the Outdoor Control Panel, Indoor Control Panel, or Wireless Remote. Tap the **Update From USB** button to display the Select Firmware File for Update screen. Using the Up/Down arrows, locate the Update file (.pfw). Tap the file name to begin the update. Follow the screen prompts.

4. **Update the System Firmware:** Insert the USB device into the USB port on the Indoor Control Panel. The USB device will be detected. The latest firmware will be copied onto the Wireless Remote. To view the firmware version, from the Home screen, tap **Settings > Advanced System Configuration > System** to view the Firmware version displayed on the System Information button.

IntelliCenter™ Automation System For Pool and Spa Menu

Home Screen:

- Pool Screen
- Spa Screen
- Features (Individual/Groups)
- Lights (Individual/Groups)
- Schedule (Weekly, One Time Only Schedule)
- Usage
- Chemistry (IntelliChem® Controller/IntelliChlor® SCG)
- Status

Settings:

- Service Mode
- Vacation Mode
- Support
- General: Location, Date & Time, Units (Fahrenheit/Celsius), Features and Lights List Order, General List Order, Backlight (Deep Sleep): Wireless Control Panel only, Temperature Sensor Calibration, Day / Night Themes, Manual Operation Priority, Manual Heat, Chemistry Readings Badge, Badge Colors.
- Alerts and Notifications: Choose which system status, alerts and warnings badges to display on the Home screen Status icon.
- Security (Passcode Protect)
- Pentair User Portal (intelllicenter.com)
- Groups: Configure groups of AUX circuits, Light circuits and Feature circuits.
- System Reboot: Reboot the panel

Advanced System Configuration

Installation Setup:

- Body Configuration, Circuits, Pumps, Heaters, Valves, Chemistry, Pool/Spa Cover.
- Remotes Setup: iS4, QuickTouch II, iS10, SpaCommand remotes
- Network and WiFi Setup: Configure Ethernet, Connect to a Wireless Network, Adjust Wireless Transmit Power, Internet Connection Test, Reboot WiFi Device.
- IntelliCenter Wireless Remote Setup: Configure the Address and Panel # for wireless remote.
- Delays: Valve Delay, Heater Cool Down, Freeze Cycle Time (min), Spa Freeze Override (min), Override Delays.
- System: System Information, Detected Hardware, System Diagnostic Information, Firmware Update (Update from Panel, Update from USB, Update from Ethernet), Factory Diagnostics.
- Import/Export: Import System Configuration, Export System Configuration.
- Restore Factory Defaults:** Restore system to factory configuration.
- Setup Wizard: Step-by-step system configuration.



1620 HAWKINS AVE., SANFORD, NC 27330 • (919) 566-8000
10951 WEST LOS ANGELES AVE., MOORPARK, CA 93021 • (805) 553-5000

www.pentair.com

All indicated Pentair trademarks and logos are property of Pentair Inc. or its global affiliates in the U.S.A. and/or other countries.
Third party registered and unregistered trademarks and logos are the property of their respective owners

© 2020 Pentair. All rights reserved. This document is subject to change without notice.



P/N 523229 Rev D 2/2020