



QuickTouch® II Wireless Remote

(For EasyTouch®, IntelliTouch®
and SunTouch® Control Systems)



Installation and User's Guide

IMPORTANT SAFETY INSTRUCTIONS
READ AND FOLLOW ALL INSTRUCTIONS
SAVE THESE INSTRUCTIONS

Technical Support

Phone: (800) 831-7133 - Fax: (800) 284-4151

visit www.pentairpool.com and www.staritepool.com

CONTENTS

IMPORTANT WARNING AND SAFETY INSTRUCTIONS	i
QuickTouch II Wireless Remote Overview	1
QuickTouch II Wireless Remote Buttons/LED	2
Setup QuickTouch II Wireless Remote Receive	3
Connecting the QuickTouch II Receiver to the Load Center	4
Wiring the QuickTouch II Receiver to SunTouch Power Center	6
QuickTouch II Wireless Remote Receiver Antenna Location	7
Mounting the QuickTouch II Receiver Module	8
Troubleshooting	10
QuickTouch II Remote Battery Replacement	11

© 2011 Pentair Water Pool and Spa, Inc. All rights reserved.

1620 Hawkins Ave., Sanford, NC 27330 • (919) 566-8000

10951 West Los Angeles Ave., Moorpark, CA 93021 • (805) 553-5000

QuickTouch®, IntelliTouch®, EasyTouch®, SunTouch®, Compool® and Pentair Water Pool and Spa® is a registered trademark of Pentair Water Pool and Spa, Inc. and/or its affiliated companies in the United States and/or other countries. Unless noted, names and brands of others that may be used in this document are not used to indicate an affiliation or endorsement between the proprietors of these names and brands and Pentair Water Pool and Spa, Inc. Those names and brands may be the trademarks or registered trademarks of those parties or others.

P/N 521362 Rev A - 07/19/11

IMPORTANT WARNING AND SAFETY INSTRUCTIONS



SERIOUS BODILY INJURY OR DEATH CAN RESULT IF THIS PRODUCT IS NOT INSTALLED AND USED CORRECTLY.



INSTALLERS, POOL OPERATORS AND POOL OWNERS MUST READ THESE WARNINGS AND ALL INSTRUCTIONS BEFORE USING THE POOL AND/OR SPA LED LIGHT.



Most states and local codes regulate the construction, installation, and operation of public pools and spas, and the construction of residential pools and spas. It is important to comply with these codes, many of which directly regulate the installation and use of this product. Consult your local building and health codes for more information.



IMPORTANT NOTICE - Attention Installer: This Installation and User's Guide ("Guide") contains important information about the installation, operation and safe use of this underwater pool and spa light. This Guide should be given to the owner and/or operator of this equipment.



Before installing this product, read and follow all warning notices and instructions in this Guide. Failure to follow warnings and instructions can result in severe injury, death, or property damage. Call (800) 831-7133 for additional free copies of these instructions. Please refer to www.pentairpool.com for more information related to this products.



Do not use this product to control an automatic pool cover. Swimmers may become entrapped underneath the cover.



The QuickTouch® II four function wireless remote must be installed by a qualified pool professional in accordance with the National Electrical Code (NEC), NFPA 70 or the Canadian Electrical Code (CEC), CSA C22.1. All applicable local installation codes and ordinances must also be adhered to. Improper installation will create an electrical hazard which could result in death or serious injury to pool users, installers or others due to electrical shock, and may also cause damage to property. Always disconnect the power to the pool light at the circuit breaker before servicing the light. Failure to do so could result in death or serious injury to serviceman, pool users or others due to electrical shock.



Risk of Electrical Shock or Electrocution!

Always disconnect the AC power to the control system load center and power center at the circuit breaker before installing or servicing the QuickTouch II wireless remote. Failure to do so could result in death or serious injury to serviceman, pool users or others due to electrical shock.

IMPORTANT WARNING AND SAFETY INSTRUCTIONS



CAUTION: IMPORTANT BATTERY INFORMATION

- Dispose of used batteries according to the manufacturer's instructions.
- There are two 3V lithium batteries (CR2032) in the QuickTouch® II wireless remote, with normal use the remote should last for several years. If the batteries need to be replaced, see page 13 for instructions.

⚠ FCC Regulatory Safety Notice -

This equipment has been tested and found to comply with the limits for a Class B digital device, pursuant to Part 15 of the FCC Rules. These limits are designed to provide reasonable protection against harmful interference in a residential installation. This equipment generates, uses and can radiate radio frequency energy and, if not installed and used in accordance with the instructions, may cause harmful interference to radio communications. However, there is no guarantee that interference will not occur in a particular installation. If this equipment does cause harmful interference to radio or television reception, which

can be determined by turning the equipment off and on, the user is encouraged to try to correct the interference by one or more of the following measures:

- Reorient or relocate the receiving antenna.
- Increase the separation between the equipment and receiver.
- Connect the equipment into an outlet on a circuit different from that to which the receiver is connected.
- Consult the dealer or an experienced radio/TV technician for help.
- Modifications not expressly approved by the party responsible for FCC compliance could void the user's authority to operate the equipment.

⚠ RF Exposure Requirements: This Device must **not** be co-located or operated in conjunction with any other antenna or transmitter.

⚠ IC Regulatory Notice

Operation is subject to the following two conditions: (1) this device may not cause interference, and (2) this device must accept any interference, including interference that may cause undesired operation of the device.

IMPORTANT - To avoid damage to the remote, never submerge in water. The QuickTouch II wireless remote is water resistant only and can be exposed to temporary splashing or wet hands. However, the remote is not intended to be submersed. Remove unit immediately if it is dropped in water or exposed to rain. Store the unit indoors in a dry environment. For more information see page 1.

QuickTouch® II Wireless Remote Overview

The QuickTouch® II hand-held wireless remote can control up to four pool/spa circuits functions such as lights, jet pump, air blower, waterfall, etc.

The QuickTouch II wireless remote is for use with EasyTouch®, IntelliTouch®, SunTouch® and Compool® to EasyTouch Upgrade control systems. EasyTouch, IntelliTouch and SunTouch control systems supports one QuickTouch II wireless remote per system.

What to do if the remote is submerged in water: The QuickTouch II wireless remote may be used with wet hands. The QuickTouch II wireless remote is water resistant only and can be exposed to temporary splashing or wet hands. However, the remote is not intended to be submersed. Remove remote immediately if it's dropped in water or exposed to rain. If accidental submersion occurs, remove the batteries from the remote. Let the water drain out of the remote. Allow the batteries to dry completely. Reassemble the unit when completely dry.

QuickTouch II Wireless Remote kit contents

- Four function wireless remote
- Label Set
- Receiver assembly - Includes circuit board, enclosure and 15 ft. cable
- Plastic anchors (qty.4) for mounting Receiver to concrete or stucco walls
- Mounting screws (qty. 4): Two screws for mounting the receiver and two screws for the enclosure
- User's and Installation Guide (this manual)

QuickTouch II Antenna Receiver Location

The QuickTouch II wireless remote has an operating range of up to 250 ft. (line-of-sight) from the QuickTouch II antenna receiver, which is typically located near the load center. The optimum wireless transmission range may be affected by physical obstructions, (especially those containing metal), and geographical features.

Replacement Kit Part Numbers

- QuickTouch II remote replacement kit (P/N 521245)
- QuickTouch II receiver replacement kit (P/N 521246)

IMPORTANT!

The QuickTouch II hand-held remote may be used with wet hands, but should never be submerged in water, as this could damage the unit. If accidental submerged in water, dry the unit out by removing the battery cover and removing the battery. Position the unit so that the water can drain out. Reassemble the unit when completely dry.

Related manuals - Download the following manuals:

IntelliTouch User's Guide: <http://www.pentairpool.com/pdfs/IntelliTouchUG.pdf>

EasyTouch User's Guide: <http://www.pentairpool.com/pdfs/easytouch8and4UG.pdf>

SunTouch User's Guide: <http://www.pentairpool.com/pdfs/suntouchUG.pdf>

QuickTouch II Wireless Remote Buttons/LED

The QuickTouch II wireless hand-held remote buttons can be setup to control up to four circuit functions. To activate a circuit function, press and hold the circuit "ON" button for at least a full second (LED indicator will flicker). To switch a circuit "OFF", press and hold the "OFF" button. Affix a circuit function label (provided) between each button to identify the button function.

Transmitter remote factory preset button assignments

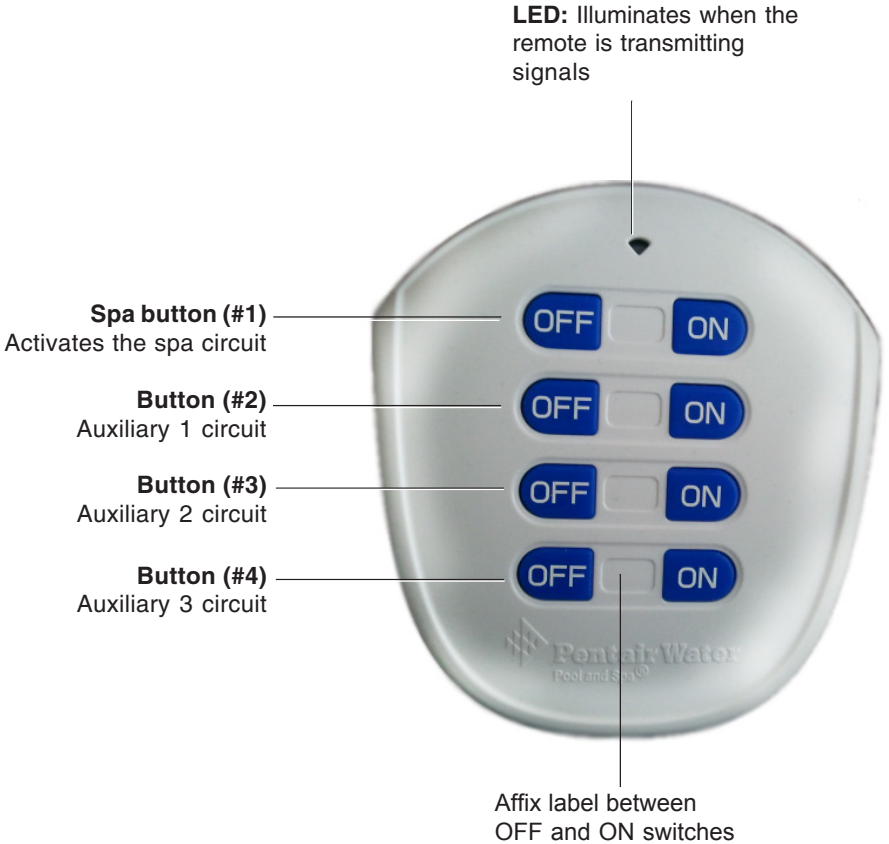

Setup QuickTouch II Wireless Remote Receive

The following describes how to setup your QuickTouch II wireless remote to communicate to the QuickTouch II receiver.

To setup the QuickTouch II remote to communicate with the wireless receiver:

1. Open receiver case.
2. Press the **White Receiver button** (shown below).
3. An LED on the QuickTouch II receiver will flash three (3) times (once the Receiver button is pressed, you have 60 seconds to connect the QuickTouch II remote to the receiver).
4. Hold down button four (4) and button eight (8) simultaneously.
5. The QuickTouch II remote can now communicate with the receiver. Check all of the remote buttons to make sure they operate correctly.

Note: One receiver can communicate with up to eight QuickTouch II remotes.



CONNECTING THE QUICKTOUCH II RECEIVER TO THE LOAD CENTER

⚠ WARNING

All electrical installation, including electrical wiring methods and materials used to complete the electrical installation of the EasyTouch, IntelliTouch and SunTouch Pool/Spa control system **MUST BE PERFORMED BY A SERVICE PROFESSIONAL AND/OR UNDER DIRECT SUPERVISION OF A QUALIFIED ELECTRICIAN** in accordance with the National Electrical Code or the Canadian Electric Code, as well as any local electrical codes in effect at the time of installation. **Refer to NEC 680-21 (b) or CEC 687-060, 062, and 066 for further details.**

The QuickTouch II receiver is connected to the EasyTouch, IntelliTouch and SunTouch system via a four-conductor communication cable. **For receiver antenna location, see page 13.**

To connect the receiver cable to EasyTouch or IntelliTouch load center:

1.

⚠ DANGER



Switch OFF the power to the load center at the main circuit breaker before removing the High Voltage Cover Panel. Failure to do so could result in personal injury and/or death. Shorting wires may permanently damage the device and load center. Close all panels and load center front door when remote installation is complete.

2. Unlatch the load center front door spring latch, and open the front door.
3. Remove the two screws securing the **high voltage cover-panel**, and remove it from the enclosure (illustration below shows cover-panel removed).
4. Loosen the two control panel access screws and fold down the outdoor control panel.

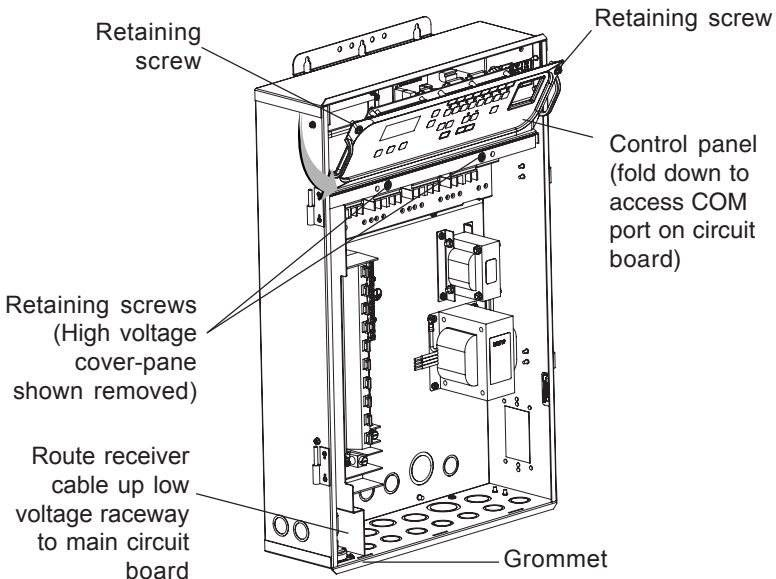

5. Insert the four conductor (22 AWG) cable into the plastic grommet on the bottom of the enclosure and route the wire up through the low voltage raceway to the main circuit board.
6. Strip back the conductors ¼-inch.
7. **EasyTouch System:** Insert the conductors into the COM PORT (J20) screw terminals located on the top of the EasyTouch circuit board (see diagram below). Secure the wires with the screws. For wiring details, refer to the pin configuration shown below. Note: Multiple wires may be inserted into a single screw terminal.

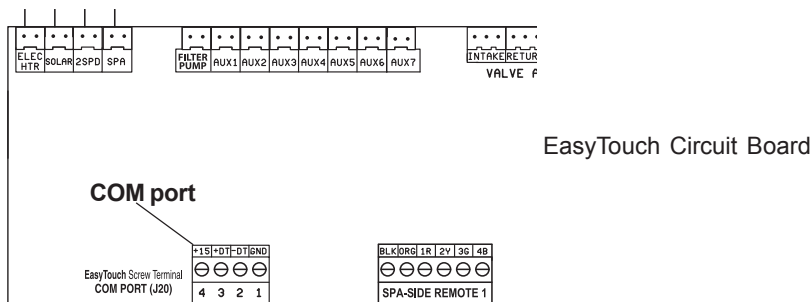

IntelliTouch System: Insert the wire into either of the COM PORTS (J7 and J8) screw terminals located on the left side of the Personality board. Secure the wires with the screws. For wiring details, refer to the pin configuration shown below. Note: Multiple wires may be inserted into a single screw terminal.

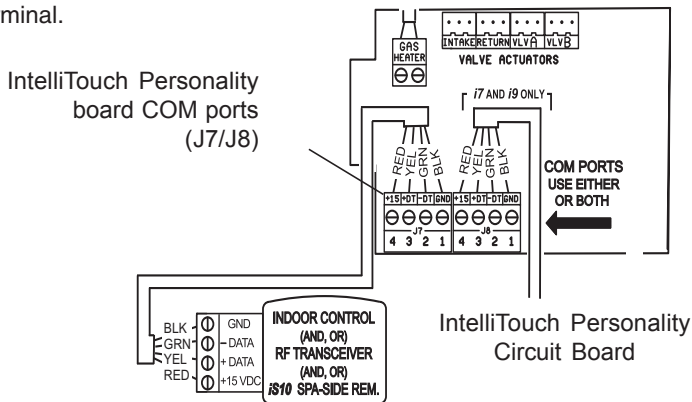

8. Close the control panel and secure it with the two access screws.
9. Install the high voltage panel cover and secure it with the two retaining screws.
10. Close the load center front door and secure with the latch.
11. Switch power on to the load center.

WIRING THE QUICKTOUCH II RECEIVER TO SUNTOUCH POWER CENTER

The QuickTouch II receiver is connected to the SunTouch system via an RS-485 four conductor communication cable.

To connect the receiver cable to the SunTouch power center:

1.



Switch OFF the power to the load center at the main circuit breaker before removing the High Voltage Cover Panel. Failure to do so could result in personal injury and/or death. Shorting wires may permanently damage the remote and load center. Close all panels and load center front door when remote installation is complete.

2. Unlatch the front door of the SunTouch Power Center, and open the door.
3. Loosen the retaining screw on front panel. Open the hinged front panel to access the electronics compartment.
4. Insert the four conductor (22 AWG) cable into the plastic grommet opening located on the left side, and up through the low voltage raceway to the SunTouch circuit board.
6. Strip back the conductors ¼-inch.
7. Insert the connector on the COM PORT (J11) screw terminal on the motherboard. Secure the wires with the screws. Make sure to match the color coding of the wires; Yellow = +DT, Green = -DT. Note: Multiple wires may be inserted into a single screw terminal.
8. When the connection is completed, close the control panel and secure it with the retaining screw.
9. Close the front door. Fasten the spring latch.

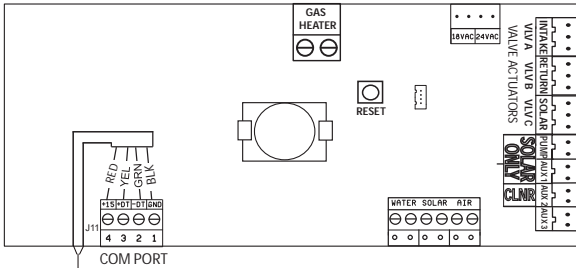
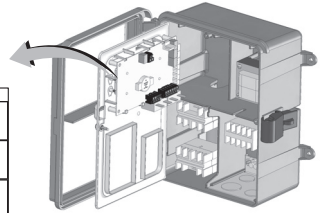

Connect to receiver



QuickTouch II Wireless Remote Receiver Antenna Location

The optimum wireless receive range for the QuickTouch II receiver may be affected by physical obstructions, (especially those containing metal), weather conditions, and geographical features. The QuickTouch II wireless remote has an operating range of up to 250 ft. (line-of-sight) from the receiver. The receiver kit includes a 15 ft. connection cable. If needed, using extra cable, the cable length can be lengthened to 300 ft. The recommended locations for the receiver are shown below.

Note: Only **one** unique QuickTouch II wireless remote receiver can be used per EasyTouch, IntelliTouch or SunTouch system.

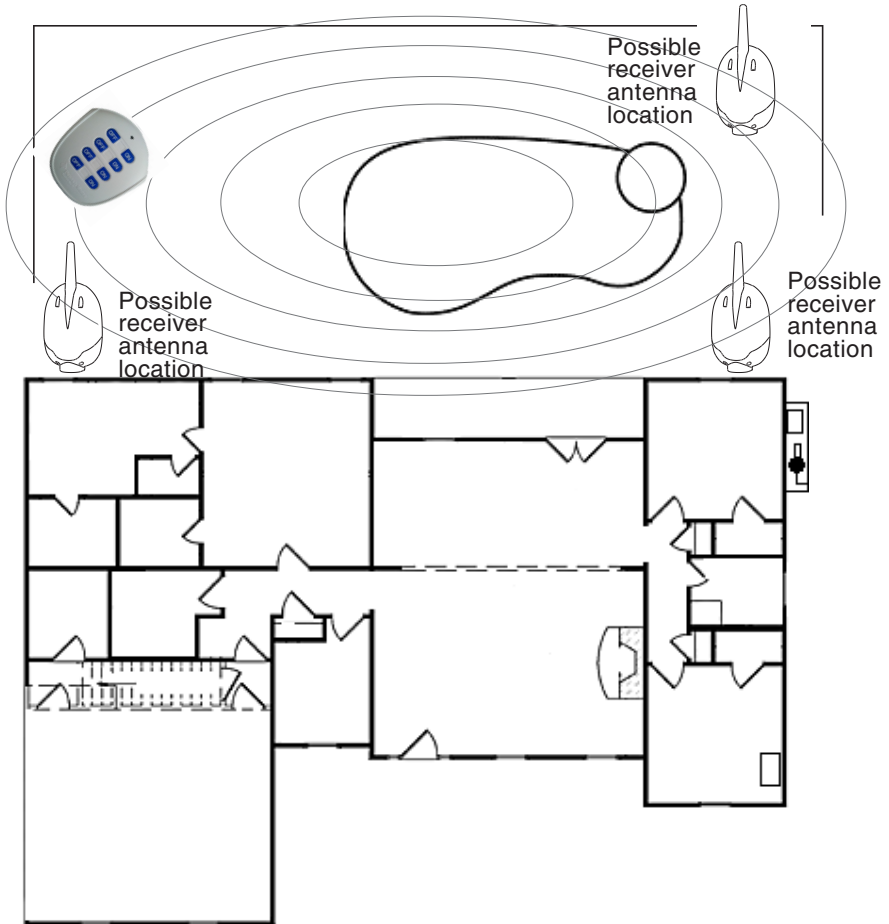

Mounting the QuickTouch II Receiver Module

The QuickTouch II wireless remote has an operating range of up to 250 ft. (line-of-sight) from the receiver.

To install the receiver:

1. Choose an installation location for the receiver near the load center.
2. Remove the two lower retaining screws from the receiver and slide the receiver case up to remove it from the back plate.
3. Remove the receiver circuit board from the back plate by carefully lifting it up out of the back plate supports. Place the circuit board on a clean dry surface away from direct sunlight.
4. Mount the receiver back plate (see page 9) onto a flat wooden surface, such as a wooden fence, or post. While holding the back plate, install two lower mounting screws through the back plate lower mounting holes. Tighten the screws to secure the back plate in place. Install two screws through the upper mounting holes.
5. Slide the receiver circuit board into the back plate into the board side supports.
6. Route the receiver cable up through the bottom of the back plate (see page 11) to the screw terminal connector.
7. Insert the four wires into the screw terminals of the receiver connector. Using a small flat-blade screwdriver, secure the wires with the screws. Make sure to match the color coding of the four wires (see page 12 for wiring diagram).
8. Carefully slide the case over the receiver antenna and secure it to the back plate with the two lower retaining screws.

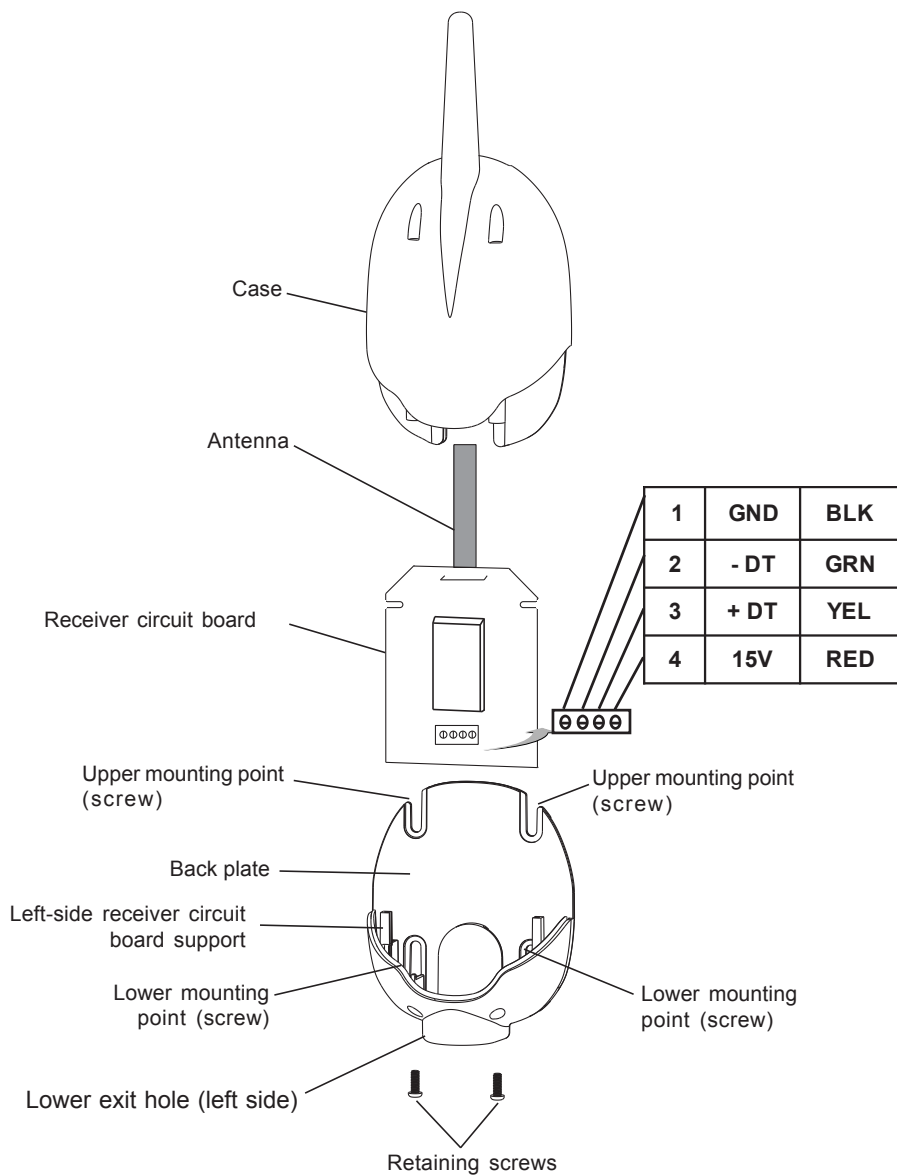

Receiver Module

Troubleshooting

Symptom	Possible Cause	Solution
POWER LED does not light.	Control Center does not have power.	Ensure power is being supplied and that the Control Center operates correctly without the Receiver installed.
	Defective cable or connection to the Control Center.	Verify the function of the board using known good cable set.
	Defective Receiver board.	Contact Factory or Service center.
RS 485 LED does not light when Transmitter button(s) are pressed; unit fails to operate.	Defective cable or connection to the Control Center.	Verify the function of the board using known good cable set.
	Transmitter battery has failed.	Replace Transmitter batteries.
	Defective Transmitter or Receiver.	Contact Factory or Service center.
Unit functions, but some circuits do not work, or operate the incorrect circuit.	Defective Transmitter or Receiver.	Contact Factory or Service center.
Unit fails to operate, or fails to dependably at range.	Undue electrical noise.	Relocate the Receiver away from operating equipment such as blower motors.
	Too many obstructions between the Transmitter and Receiver.	Relocate the Receiver to place that provides fewer obstructions to the area user commonly operates the Transmitter.
	Receiver unit is too near the ground.	Relocate the Receiver to maximize the distance between the Receiver antenna and the ground.
Unit seems to turn ON or OFF circuits without the user / Transmitter	A home nearby is operating similar wireless unit.	Repeat setup for the Transmitter and Receiver. See page 3.
Unit dependably turns equipment ON, but once equipment is running it equipment does not dependably turn equipment OFF, or range is greatly reduced when equipment is running.	Undue electrical noise is being produced by one or more pieces of equipment such as blower motors OR in close proximity to the Receiver.	Relocate the Receiver away from relocate the Receiver in a location that provides fewer obstructions to the area the user commonly operates the Transmitter.
Unit operates, but has greatly reduced range compared to prior function.	Transmitter battery is failing.	Replace transmitter batteries.

QuickTouch II Remote Battery Replacement

The QuickTouch II wireless remote has two 3V lithium CR2032 batteries located on the circuit board. With normal use the remote batteries should last for several years. In the event the battery must be replaced, discard in accordance with local and/or state ordinances.

To replace the two batteries:

1. Place the QuickTouch II remote face down on a flat clean surface. Remove the screw securing the back cover.
2. Insert a small flat-blade screw driver into the notches located on the top of the remote and gently pry the two halves apart. Separate the front and back cover.
3. Remove the screw securing the circuit board to the back cover.
4. Lift the circuit board out of the back cover.
5. The batteries are located on the back of the circuit board. To replace each battery, grip the side of the battery and slide it out of its support. Note: Always replace both batteries. Replace batteries with positive (+) face up.
6. Place the circuit board (buttons facing up) onto the plastic supports in the back cover. Secure the circuit board in place with the retaining screw.
7. Place the back cover over the front cover and snap the two halves together. Secure the covers with the retaining screw.
8. Check the battery replacement: Press each button and verify that the LED blinks when each button is pressed.

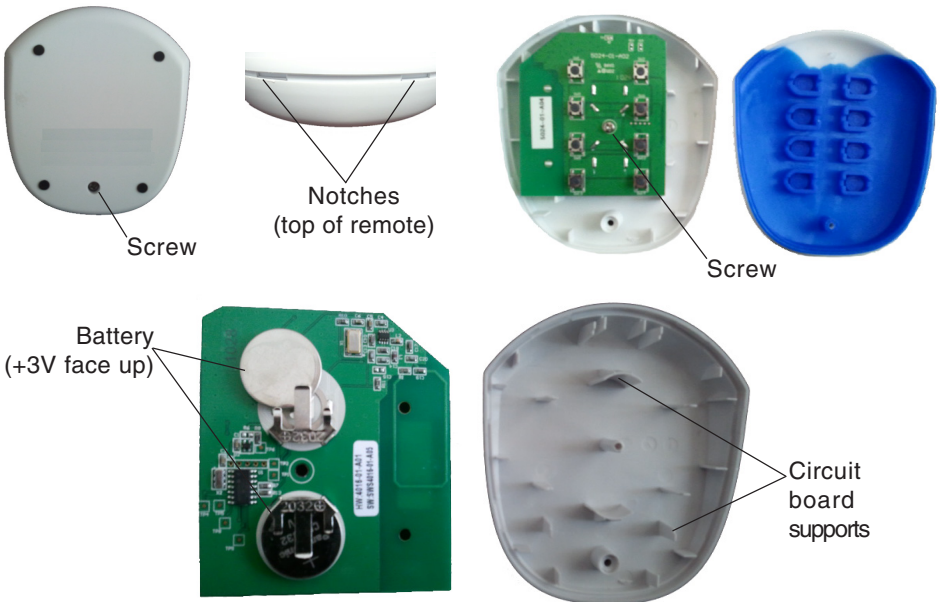



P/N 521362 Rev A