



**FAIRBANKS NIJHUIS™**

MODEL 4600CE  
**VORTEX PUMPS**  
**(RECESSED IMPELLER)**

**INSTALLATION, OPERATION AND MAINTENANCE MANUAL**

NOTE! To the installer: Please make sure you provide this manual to the owner of the equipment or to the responsible party who maintains the system.

## **PUMP/MOTOR IDENTIFICATION**

Carefully record all of the following data from your pump/motor nameplate. It will aid in obtaining the correct replacement parts for your pump. In addition to the nameplate, the pump serial number is also stamped on the discharge flange.

### **Pump:**

Serial Number \_\_\_\_\_  
Size \_\_\_\_\_ Model # \_\_\_\_\_  
GPM \_\_\_\_\_ Head \_\_\_\_\_ (feet)  
BHP: \_\_\_\_\_ RPM: \_\_\_\_\_  
Pump Weight \_\_\_\_\_ (lbs.) \_\_\_\_\_

### **Motor:**

Horsepower \_\_\_\_\_  
Serial Number \_\_\_\_\_  
Motor Frame \_\_\_\_\_  
Full Load Speed \_\_\_\_\_  
Full Load Amps \_\_\_\_\_  
Phase/Hz/Volts \_\_\_\_\_ / \_\_\_\_\_ / \_\_\_\_\_  
Motor Weight \_\_\_\_\_  
Motor Identification Number \_\_\_\_\_

Date Placed in Service \_\_\_\_\_

## **WARRANTY HIGHLIGHTS**

- 1) Seller warrants products of its own manufacture against defects in materials and workmanship under normal use and service for: one (1) year from date of start up, not to exceed 18 months from date of shipment.
- 2) Accessories and components not manufactured by seller are warranted only to the extent of the original manufacturer's warranty.
- 3) No allowances will be made for repairs or alterations effected without specific written authorization from Seller.
- 4) The equipment as manufactured by Fairbanks Morse Pump is precision machinery. Proper care can give a lifetime of satisfactory service. Warranties of performance are based on the use of original equipment manufactured (OEM) replacement parts. Fairbanks Morse Pump shall assume no responsibility when alterations, non-authorized design modifications and/or non-OEM replacement parts are incorporated.
- 5) This warranty is VOID unless the purchaser provides protective storage, installs and maintains the equipment in accordance with manufacturer's instructions.
- 6) Under the terms of this warranty, Seller shall not be responsible nor liable for:
  - a) Consequential, collateral or special losses or damages.
  - b) Equipment conditions caused by fair wear and tear, abnormal conditions of use, accident, neglect, or misuse of said equipment.
  - c) In-shop labor charges after the first 12 months from installation.
  - d) Loss or damage resulting from supplying of defective part(s) or improper repairs by unauthorized person(s).
  - e) Damage caused by abrasive materials, chemicals, scale deposits, corrosion, lightning, improper voltage or mishandling.
  - f) Labor charges for installation, removal or reinstallation of equipment.
- 7) The above listed warranty highlights do not constitute our total terms and conditions regarding warranty. For complete warranty information please refer to complete warranty statement herein.

## **LOSS OR DAMAGE IN TRANSIT**

Immediately upon receipt, a complete inspection and accounting against the packing list should be made of all major components, and accompanying boxes or pallets. All material is shipped F.O.B. our factory, or our vendor's shipping point unless optional contractual arrangements are made. Under these terms, any claims for loss or damage in transit should be immediately directed to the delivering freight carrier. Fairbanks Morse will assist the customer in receiving fair compensation, but assumes no responsibility to mediate such claims. This policy includes shipments wherein Fairbanks Morse pays freight costs as part of the sales terms.

If there is any indication of oil leakage from the motor oil chamber, advise the factory immediately and request instructions for proper handling.

# Terms & Conditions

1. **LEGAL EFFECT:** The following terms and conditions are a part of this Quotation, and will be a part of any order ("Order") resulting from the Quotation. Additional or different terms of Buyer's purchase order or other form of acceptance or any other form of Buyer are rejected in advance and shall not become a part of the Order. This quotation is not an offer. All offers to purchase from Buyer or orders or contracts of sale resulting from this Quotation are subject to final acceptance in writing by an authorized representative at Seller's Kansas City plant.

Seller's rights and remedies under this Quotation and the Order are in addition to, not in substitution of, all other rights and remedies available to Seller under any applicable provisions of law, regulation or court decision. Seller may suspend its performance of the Order if Buyer defaults in the performance of its duties under the Order or under any other agreement between the Buyer and Seller.

No employee, agent, dealer, or distributor of Seller has any authority to change or enlarge the terms of this Quotation or the Order. No change shall be valid unless it is in writing and signed by an authorized officer of Seller.

In the event that any provision of these terms and conditions is deemed to be invalid or unenforceable, the parties agree that such invalidity of unenforceability shall not invalidate or render unenforceable the remainder of these terms and conditions, and the remaining terms and conditions shall continue in full force and effect. The terms of any Order resulting from this Quotation shall be interpreted and enforced in accordance with the laws of Kansas.

2. **ASSIGNMENT:** Buyer may not assign or transfer any of its rights under this Quotation or the Order without Seller's written consent. However, Seller may freely assign or transfer its rights under this Quotation of the Order.

3. **CANCELLATION:** Buyer cannot cancel or alter the Order without the Seller's written consent. If Seller grants such consent, Buyer will reimburse Seller for all of Seller's losses and expenses caused by such cancellation or alteration, including without limitation all of Seller's additional costs caused by changes in design or specifications, or by product revisions, and all consequential damages incurred by Seller as a result of such cancellation or alteration. If Buyer cancels the Order, Buyer shall pay Seller (i) a minimum cancellation charge of 15 percent of the purchase price; and (ii) any damages and expenses described in this paragraph that exceed 15 percent of the purchase price.

#### 4. PRICES:

A. At Seller's option, prices for items of equipment included in this Quotation, other than equipment covered by Paragraph 4.B. will be increased in accordance with Clause 1 below, unless the "price quotation" portion of this quotation specifically refers to Clause 2.

Clause 1 -- The price for each item of equipment will be escalated by the ratio of the published price for such item (after applicable discounts) in effect at the time of shipment, over the published price for such item (after applicable discounts) in effect at the date of this Quotation.

Clause 2 -- The quoted price for each item of equipment will be subject to escalation in accordance with the price adjustment policy specified in Form KC586, which is hereby incorporated as part of this Quotation if this Clause is referred to in the "price quotation" portion of this Quotation.

B. Prices for items of equipment purchased by Seller from third parties which are not covered by Seller's published prices and which are separately identified in this Quotation (such as motors, engines, controls, etc.) will be increased by the ratio of Seller's purchase price at the time of shipment over Seller's purchase price at the time of this Quotation.

5. **TERMS OF PAYMENT:** Unless otherwise specified in this Quotation, the terms of payment shall be as follows:

a. On all Orders under \$100,000, net cash, within thirty (30) days after shipment.

b. On all Orders over \$100,000, as follows:  
15% on submittal of drawings  
25% on release to manufacture  
50% at time of shipment  
10% 30 days after shipment

These terms apply to partial and complete shipments. Buyer agrees to make full payment under these terms without setoff. If any proceeding is initiated by or against Buyer under any bankruptcy or insolvency law, or if, in Seller's judgment, Buyer's financial condition at the time the equipment is ready for shipment does not warrant the extension of credit to Buyer, Seller may require full payment, in cash, prior to making shipment. If Seller does not receive full cash payment within fifteen (15) days after it notifies Buyer that such payment is required and that the equipment is ready for shipment, Seller may cancel the Order as to any unshipped item. In that event, Buyer will pay Seller the cancellation charges, damages and expenses, as described in paragraph 3.

Seller may assess interest on all amounts past due at the highest lawful rate, or an annual rate of eighteen percent (18%), whichever rate is lower. Buyer will pay all costs and expenses, including reasonable attorney's fees, incurred by Seller in collecting any amounts due, including interest.

The date for shipment or completion of manufacture of the equipment may be changed only with Seller's written consent. If shipment is delayed at Buyer's request, Buyer will make any payments due under the order as if the equipment had been shipped on the date when it was ready for shipment. If completion of manufacture is delayed at Buyer's request, Seller may require payment according to percentage of completion. Buyer shall have the risk of loss with respect to equipment held for Buyer, and Seller may charge Buyer for storage.

6. **TAXES:** Prices do not include any present and future sales, use, occupation, license, excise, and other taxes or fees with respect to the manufacture, sales, or delivery of the equipment. If Seller pays any such taxes, the amount of such payment will be added to the purchase price. Buyer will pay all such taxes and fees unless the amounts of such taxes and fees are included in the purchase price at the proper rate, or Buyer furnishes a proper exemption certificate.

7. **ACTS OF GOD:** Seller shall in no event be liable for delays in delivery of the equipment or other failures to perform caused by fires, acts of God, strikes, labor difficulties, acts of governmental or military authorities, delays in transportation or procuring materials, or causes of any kind beyond Seller's control.

8. **DELIVERY:** Except as otherwise specified in this Quotation, delivery will be F.O.B. Seller's point of shipment. Buyer will pay all transportation charges. Buyer will accept delivery within thirty (30) days after Seller notifies Buyer that the equipment is ready for shipment. If Buyer does not furnish exact shipping instructions, Seller will select, at its discretion, the means of shipment. Seller will not be liable for any loss resulting from such selection. The time of delivery is an estimate only, and Seller may change such time if it does not receive the information and approvals necessary to proceed with the manufacture of the equipment.

Buyer agrees to inspect all deliveries immediately. Any claim for shortages must be made in writing within ten (10) days after Buyer receives a shipment, and if not made, shall be deemed waived. Any other claim by Buyer, other than claims under the warranty stated in Paragraph 13, shall be made within thirty (30) days after Buyer receives shipment, and if not made shall be deemed waived. Seller is not responsible for loss or damage in transit after having received an "In good Order" receipt from the carrier. Buyer will make all claims for loss or damage in transit against the carrier.

Buyer is fully responsible for (including payment of the cost of) installation and start-up of all equipment sold under the Order.

9. **TITLE AND LIEN RIGHTS:** The equipment will remain personal property, regardless of how it is installed or affixed to any realty or structure. After delivery to Buyer, Seller will have all such rights, including security interests and liens, in the equipment as lawfully may be conferred upon Seller by contract under any applicable provision of law. Buyer agrees to cooperate fully with Seller in the filing of any financing statements or other documents necessary to protect such interests and liens. If Buyer defaults in its obligations under the Order before the price (including any notes given therefore) of the equipment has been fully paid in cash, Seller may take any and all actions permitted by law to protect its interests including, where permissible, repossession of such equipment.

10. **PATENT INFRINGEMENT:** Seller will defend Buyer and the user of the equipment against any claim that any equipment and parts of Seller's manufacture furnished under the Order infringe upon any published United States patent, and Seller will pay all damages and costs awarded by a court of competent jurisdiction with respect to such claim. The Buyer or user must promptly notify Seller of any such claim, and cooperate fully with Seller in the defense of such claim, or Seller will have no duty under this paragraph. Buyer will defend and indemnify Seller against patent infringement claims relating to equipment and parts that are not manufactured by Seller to the same extent as Seller agrees to defend and indemnify Buyer with respect to patent infringement claims relating to equipment and parts of Seller's manufacture.

11. **SALES FOR EXPORT:** In the case of sales for export, Buyer or Seller, whichever is the proper party under the applicable statute or regulation, will procure, and arrange for any necessary extensions of, all required export, import or other licenses or authorizations. If Buyer, as the proper party, fails to arrange for such licenses or authorizations prior to or by the scheduled date of shipment, Seller may at its option treat any such failure as a cancellation of the Order and, upon notice from Seller, Buyer will pay Seller the cancellation charges, damages and expenses, as described in Paragraph 3.

12. **INSURANCE:** Buyer shall bear all risk of and responsibility for damage or loss to the equipment after Seller delivers the equipment to the carrier at its point of shipment. Buyer agrees to provide and maintain adequate insurance for the equipment supplied under the Order to fully protect Seller's interest during the time between delivery and final payment. Loss or damage by fire or other causes during such period shall not relieve Buyer from its obligations under the Order.

13. **WARRANTY:** Seller warrants equipment (and its component parts) of its own manufacture against defects in materials and workmanship under normal use and service for (1) year from the date of installation or start-up, or for eighteen (18) months after the date of shipment, whichever occurs first. Seller does not warrant accessories or components that are not manufactured by Seller however, to the extent possible, Seller agrees to assign to Buyer its rights under the original manufacturer's warranty, without recourse to Seller. Buyer must give Seller notice in writing of any alleged defect covered by this warranty (together with all identifying details, including the serial number, the type of equipment, and the date of purchase) within thirty (30) days of the discovery of such defect during the warranty period. No claim made more than 30 days after the expiration of the warranty period shall be valid.

Guarantees of performance and warranties are based on the use of original equipment manufactured (OEM) replacement parts. Fairbanks Morse Pump assumes no responsibility or liability if alterations, non-authorized design modifications and/or non-OEM replacement parts are incorporated.

If requested by Seller, any equipment (or its component parts) must be promptly returned to Seller prior to any attempted repair, or sent to an authorized service station designated by Seller, and Buyer shall prepay all shipping expenses. Seller shall not be liable for any loss or damage to goods in transit, nor will any warranty claim be valid unless the returned goods are received intact and undamaged as a result of shipment. Repaired or replaced material returned to customer will be shipped F.O.B., Seller's factory. Seller will not give Buyer credit for parts or equipment returned to Seller, and will not accept delivery of any such parts or equipment, unless Buyer has obtained Seller's approval in writing.

The warranty extends to repaired or replaced parts of Seller's manufacture for ninety (90) days or for the remainder of the original warranty period applicable to the equipment or parts being repaired or replaced. This warranty applies to the repaired or replaced part and is not extended to the product or any other component of the product being repaired.

Repair parts of its own manufacture sold after the original warranty period are warranted for a period of one (1) year from shipment against defects in materials and workmanship under normal use and service. This warranty applies to the replacement part only and is not extended to the product or any other component of the product being repaired.

Seller may substitute new equipment or improve part(s) of any equipment judged defective without further liability. All repairs or services performed by Seller, which are not covered by this warranty, will be charged in accordance with Seller's standard prices then in effect.

THIS WARRANTY IS THE SOLE WARRANTY OF SELLER AND SELLER HEREBY EXPRESSLY DISCLAIMS AND BUYER WAIVES ALL OTHER WARRANTIES EXPRESSED, IMPLIED IN LAWS OR IMPLIED IN FACT, INCLUDING ANY WARRANTIES OF MERCHANTABILITY OR FITNESS FOR A PARTICULAR PURPOSE. Seller's sole obligation under this warranty shall be, at its option, to repair or replace any equipment (or its component parts) which has a defect covered by this warranty, or to refund the purchase price of such equipment or part. Under the terms of this warranty, Seller shall not be liable for (a) consequential, collateral, special or liquidated losses or damages; (b) equipment conditions caused by normal wear and tear, abnormal conditions of use, accident, neglect, or misuse of said equipment; (c) the expense of, and loss or damage caused by, repairs or alterations made by anyone other than the Seller; (d) damage caused by abrasive materials, chemicals, scale deposits, corrosion, lightning, improper voltage, mishandling, or other similar conditions; (e) any loss, damage, or expense relating to or resulting from installation, removal or reinstallation of equipment; (f) any labor costs or charges incurred in repairing or replacing defective equipment or parts, including the cost of reinstalling parts that are repaired or replaced by Seller; (g) any expense of shipment of equipment or repaired or replacement parts; or (h) any other loss, damage or expense of any nature.

This Section 13 shall not apply to any equipment which may be separately covered by one of the following warranties: KC685 5-Year Prorated warranty, KC885 15-Month Prorated Warranty, KC985 9-Month Warranty. All other provisions of KC585 shall remain effective.

14. **CONDITION TO WARRANTY WORK:** If Buyer is in default (including, but not limited to, the failure of Buyer to maintain a current account with Seller) under the Order or any other agreement between Buyer and Seller, Buyer's rights under the warranty shall be suspended and the original warranty period will not be extended.

15. **PERFORMANCE:** Equipment performance is not warranted or guaranteed unless separately agreed to by Seller in accordance with its guarantee policy. Performance curves and other information submitted to Buyer are approximate and no warranty or guarantee shall be deemed to arise as a result of such submittal. All testing shall be done in accordance with Seller's standard policy.

16. **LIABILITY LIMITATIONS:** Under no circumstances shall the Seller have any liability under the Order or otherwise for liquidated damages or for collateral, consequential or special damages or for loss of profits, or for actual losses or for loss of production or progress of construction, regardless of the cause of such damages or losses. In any event, Seller's aggregate total liability under the Order or otherwise shall not exceed the contract price. Buyer agrees to indemnify and hold harmless Seller from all claims by third parties in excess of these limitations.

17. **COMPLIANCE WITH LAW:** Since the compliance with the various Federal, State, and Local laws and regulations, concerning occupational health and safety and pollution are affected by the use, installation and operation of the equipment and other matters over which Seller has no control, Seller assumes no responsibility for compliance with those laws and regulations, whether by way of indemnity, warranty, or otherwise.

## INTRODUCTION

Congratulations! You are the new owner of the finest pump commercially available. If you give it the proper care as outlined and recommended by this manual, it will provide you with reliable service and long life.

### IMPORTANT

- **Read this complete manual and manuals for all component equipment before assembly or installation is started. It contains information which is the result of engineering and research efforts. It is designed to supply adequate instructions for the installation, operation and maintenance of your pump. Failure or neglect to properly install, operate or maintain your pump may result in personal injury, property damage or unnecessary damage to the pump.**

This manual applies to the pump installation, operation and maintenance. They are intended to be general and not specific. If your operating conditions ever change, always refer to the factory for reapplication. Always refer to the manuals provided by manufacturers of the accessory equipment for their separate instructions.

Variations exist in both the equipment used with these pumps and in the particular installation of the pump and driver. Therefore, specific operating instructions are not within the scope of this manual. The manual contains general rules for installation, operation and maintenance of the pump. If there are questions regarding the pump or its application which are not covered in this manual, please contact the factory as follows:

Fairbanks Morse Pump  
3601 Fairbanks Avenue  
Kansas City, Kansas 66106  
Phone 913/371-5000, Fax 913/748-4025

To obtain additional data on hydraulics and pump selection and operation, we suggest you purchase both of the following reference books:

1. The Fairbanks Morse "Hydraulic Handbook" available from the Kansas City factory.
2. "Hydraulic Institute Standards" from the Hydraulic Institute, 9 Sylvan Way, Parsippany, NJ 07054-3802.

## TABLE OF CONTENTS

<b>Safety</b> .....	10
Safety Labels Used In This Manual.....	10
Emergency Procedures.....	11
Basic Safety Requirements.....	11
Sanitation Precautions.....	11
Precautionary Labels.....	12
Electrocution Hazard.....	12
Hazardous Work Permit.....	12
Safe Repair Procedures.....	13
General Guidelines for Maintenance and Repair.....	13
Lockout/Tagout.....	13
Start-Up Following Repair.....	13
Modification of Equipment.....	13
<b>Installation</b> .....	14
Receiving and Handling.....	14
Identification - Nameplate Information.....	14
Storage.....	15
Special Tools.....	15
Pump Location.....	15
Foundation.....	16
Anchor Bolts.....	16
Baseplate Grouting.....	16
Piping.....	16
Suction Piping.....	16
Discharge Piping.....	17
Isolation Joints.....	17
Service Connections.....	17
Stuffing Box Seal.....	17
Mechanical Seal.....	17
Drain Connection.....	18

Field Alignment.....	18
V-Belt Arrangement.....	18
Direct Coupled Arrangement.....	19
Belt or Coupling Guards.....	19
<b>Operation.....</b>	<b>19</b>
Pre-Startup Checklist.....	20
Startup Checklist.....	20
Turning the Pump On.....	21
Operating the Pump.....	22
Pressure Measurement.....	22
Motor Amp Draw.....	22
Power Supply Voltage.....	23
Throttling.....	23
Pump Speed.....	23
Turning the Pump Off.....	23
<b>Maintenance.....</b>	<b>24</b>
General Preventative Maintenance.....	24
Motor Maintenance and Lubrication.....	24
Belt and Sheave Maintenance.....	25
Direct Coupling Maintenance.....	25
Pump Bearing Lubrication - Oil.....	25
Pump Bearing Lubrication - Grease.....	26
Wet End Maintenance.....	26
 <b>List of Figures and Tables</b>	
<a href="#">Figure 1: Fairbanks Morse Nameplate</a> .....	15
<a href="#">Table 1: Motor Grease Quantity</a> .....	25



<b>4600CE – Assembly and Disassembly</b> .....	27
<b>4600CE Exploded View</b> .....	27
<b>Disassembly Procedure</b> .....	28
Rotating Assembly Removal – Back Pull Out Design.....	28
Impeller Removal.....	28
Wearplate Removal.....	28
Backplate and Packing Gland Housing Removal.....	29
Shaft Sleeve Removal.....	29
Shaft and Bearing Removal.....	29
Case Removal.....	30
Cleaning and Inspection.....	30
<b>Assembly Procedure</b> .....	30
Pre-Assembly Inspection.....	30
Bearing Assembly.....	30
Shaft Assembly.....	31
Bearing Caps Assembly.....	31
Packing Gland and Shaft Sleeve Assembly – Stuffing Box.....	32
Packing Gland and Shaft Sleeve Assembly – Mechanical Seal.....	32
Wearplate Installation.....	33
Impeller Installation.....	33
Case Installation.....	33
 <b>List of Figures and Tables</b>	
<a href="#"><u>Table 2: 4600CE Packing Arrangement and Size</u></a> .....	32
<a href="#"><u>Table 3: 4600CE Impeller Fastening Torque Values</u></a> .....	33

## **Safety**

This chapter contains information to promote safety in the operation and maintenance of this equipment. It is not intended to supersede, replicate, or replace any safety documentation or procedures provided from or established by official safety sources.

All persons involved in the operation of this equipment—plant engineering, operations, and management—must understand the potential hazards involved and observe the required safety precautions. Only trained and responsible personnel should work with or around this equipment.

Your safety and the safety of equipment, nearby facilities, and personnel require a proper safety attitude and an emphasis on safe work procedures. This is the essence of any good safety program. If at any time you identify safety deficiencies, immediately correct them and bring them to the attention of management. Before an accident can be prevented, it must be anticipated. Use pre-job discussions with your co-workers and supervisors to identify hazards and the means to avoid them.

### **Safety Labels Used In This Manual**

Failure to follow the procedures in this manual can lead to injury, loss of property, or death. In most cases, particularly sensitive procedures are called out with the following symbols:



**Procedures that can jeopardize the pumping unit or other property are designated with this symbol.**

---



**Procedures that have a general hazard to personnel or safety are designated with this symbol.**

---



**Procedures that pose a risk of electrocution are designated with this symbol.**

---

Information that is critical to the safe operation of the equipment is called out with the following symbol:

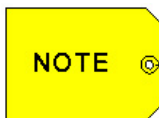

**This symbol calls out important information that may not be included in the text.**

---

### **Emergency Procedures**

The Fairbanks Morse pump is designed to operate safely, efficiently, and reliably. However, as with any operating system, an emergency can occur at any time. An emergency response could involve calling for medical assistance, management notification, fire assistance, or evacuation from the vicinity of the equipment. Obtain the following emergency phone numbers and post them at site telephone locations. Periodically review the numbers for accuracy and update them as required.

**Table 1.1 Emergency Phone Numbers**

Ambulance	(____) _____ - _____
Fire Department	(____) _____ - _____
Police Department	(____) _____ - _____
Fairbanks Morse Representative	( 913) 371-5000

Training and education are the most important parts of any safety program. For every possible emergency, establish an Emergency Response Plan and maintain it for immediate use.

### **Basic Safety Requirements**

Be aware of the following safety guidelines:

- Prevent electrical shock – Disconnect the power cord from the equipment before working on it. Use tools designed for work on electrical equipment.
- Prevent injury – Wear safety glasses and other appropriate safety protection when the Material Safety Data Sheet or safe working procedure dictates. Ensure that all tools and instruments used during installation and maintenance are in good condition.
- Protect equipment and personnel – Check all safety devices periodically to ensure continued reliability. Provide proper maintenance of all safety valves. Never bypass safety devices, and never operate the equipment outside its specified limits.
- Follow posted precautions – Read all precautionary labels attached to equipment and posted in areas of the facility. Comply with all precautions before handling the equipment.

Situations may develop for which no written procedures exist. Think carefully before acting. Know the function of each part and its effect on the process and equipment. Carefully review all operating procedures before starting up this equipment to ensure knowledge and understanding.

### **Sanitation Precautions**



**Follow the safety precautions established by your facility for wastewater sanitation.**

---

---

Wastewater contains potentially dangerous bacteria, viruses, and pathogens. When working in or around equipment operating in wastewater treatment facilities, exercise all required precautions for personal sanitation.

## Precautionary Labels

---



**To avoid serious injury, read all precautionary labels attached to equipment and boxes prior to start-up.**

---

The precautionary labels warn you of inherent hazards associated with the system. Before handling the equipment, read and understand the precautionary labels and follow the instructions they contain. Do not remove or obscure any label. If a label is missing or difficult to read, replace it with a new one. Labels are available from your Fairbanks Morse representative.

## Electrocution Hazard

---



**Electric shock can kill. Use extreme caution if troubleshooting or servicing this equipment. Do NOT bypass safety interlocks. An electrocution hazard exists even after the equipment has been de-energized. Only qualified personnel who are in compliance with all applicable federal, state, and local codes shall perform electrical wiring.**

---

Adherence to the following guidelines will help guard against possible electrocution:

- Use only factory-approved components for repair. Tampering or unauthorized substitution of components may adversely affect the safety of this equipment.
- Turn off the power before opening the equipment, or checking or replacing any component.
- Carefully follow all Hazardous Work Permit and Lockout/Tagout procedures for your facility.
- Do not touch live electrical components inside the equipment; electric shock caused by voltage in the control circuits can kill.
- Keep all equipment surfaces very clean. Do not allow grease or oil deposits on bypass interlocks or other safety devices.

## Hazardous Work Permit

The purpose of a Hazardous Work Permit (HWP) is to ensure that work known to be hazardous, or that could cause a hazard, is planned and controlled so that it is accomplished without incident. Planning the procedures and conducting a pre-job discussion with all of the participants, including a responsible manager, are necessary to ensure a safe work process.

The most successful way to avoid accidents is to anticipate them. In a pre-job discussion, the participants identify all the potential hazards and develop procedures for accomplishing the task without risk. The process is formalized and the work is begun only after the manager has issued a written permit.

The following are examples of work on the equipment that should be covered by an HWP:

- Confined space entry
- Welding and cutting
- Electrical repairs and troubleshooting of controls
- Repairs on piping that may be under pressure
- Any task that plant supervision has designated as being hazardous

### **Safe Repair Procedures**

---

---



**Failure to properly isolate equipment and piping may cause injury. Be sure to positively isolate the equipment before repair work is performed.**

---

### **General Guidelines for Maintenance and Repair**

The following guidelines should be adhered to during routine maintenance and repair work:

- All repair work must be performed by a qualified service technician.
- Properly size piping to allow safety devices to operate according to specifications.
- De-pressurize pump and piping before working on them.
- If possible, do not stand on the unit to perform maintenance. Your Fairbanks Morse pump is not constructed to support the weight of a person.

### **Lockout/Tagout**

All personnel must be protected from hazards related to unexpected energizing, start-up, or release of stored energy during equipment servicing or maintenance. Strict equipment Lockout/Tagout procedures ensure that all personnel are protected while performing necessary maintenance and servicing work.

### **Start-Up Following Repair**

Before restarting the equipment, ensure that all parts of the equipment affected by repairs have been restored to their proper operating condition.

### **Modification of Equipment**

Conversions and modifications to your equipment are permissible only with the written agreement of Fairbanks Morse. Original manufacturer replacement parts and Fairbanks Morse approved accessories enhance the operational safety of the machine. The use of non-Fairbanks Morse parts or accessories can lead to the nullification of Fairbanks Morse liability for any resultant damage or loss of property.

If modifications to the pump are carried out in agreement with Fairbanks Morse, a new set of operating instructions will be provided, or the existing manual will be supplemented with additional sheets and a new cover sheet. The date of modification will be listed on the new cover sheet.

## Installation



Installation of your Fairbanks Morse pump involves potentially hazardous conditions. Only trained and qualified personnel should install and maintain this equipment.

### Receiving and Handling



Your Fairbanks Morse pump is very heavy. Handle it carefully. Careless handling can result in equipment damage and injury to personnel.

Upon receipt of your Fairbanks Morse pump:

- Verify that no damage has occurred during transit. Carefully inspect the base, motor fan guard, the motor fan, exposed shafts, suction and discharge flanges, coupling and belt guards, and note any damage to painted surfaces.
- Check off all parts and accessories against the packing list and bill of lading to ensure proper contents.

If you find any damage or shortage, immediately notify your Fairbanks Morse representative. To obtain credit, you must notify your Fairbanks Morse representative within seven days of delivery. DO NOT sign any receiving tickets or acceptance papers unless the shipment is in proper condition and all accessories are accounted for.

After you receive and inspect your pump, transfer it to the assembly location or storage area. Use the proper forklift truck for lifting items on pallets or in crates. The lift forks should extend under the equipment and completely support the unit. When necessary to lift by crane, use the vertical points of the equipment or the crating for pickup so the equipment remains level. Use long lift cables, chains, or straps, as required, to evenly support the equipment. In addition, use a spreader bar, if necessary, to ensure a vertical pull at all lift points. Short cables or chains can create a cross shear that can damage the equipment.



If your pump is supplied with a motor and baseplate, lift only from the lifting lugs provided. Do not lift from the motor or the pump to support the entire package. Doing so can result in damage to the pump.

Leave the pump assembly crated, horizontal, and stored in a warm, dry location until you are ready to install it.

### Identification - Nameplate Information

Each Fairbanks Morse unit is supplied with a corrosion resistant nameplate affixed to the pump.



<b>Serial No.</b>	<input type="text"/>	<b>Capacity</b>	<input type="text"/>
<b>P.O. No.</b>	<input type="text"/>	<b>Head</b>	<input type="text"/>
<b>Model No.</b>	<input type="text"/>	<b>RPM</b>	<input type="text"/>
<b>Tag No.</b>	<input type="text"/>	<b>Material</b>	<input type="text"/>

 **Made in the United States of America**

**Figure 1: Fairbanks Morse Nameplate**

You will need the information on the nameplate when inquiring about parts and service. Since the nameplate can be damaged in the field, Fairbanks Morse suggests copying this information in this manual for future reference.

### **Storage**

If you do not install the pump soon after receipt, use the following storage procedures to ensure the unit remains in good working condition. Fairbanks Morse DOES NOT prepare the pump package for long term storage.

- Remove the packing glands, packing, and lantern ring from the stuffing box. If the pump has a mechanical seal, coat the seal faces with a light lubricating oil.
- Cover all suction and discharge flanges with wood, plastic, or tape to prevent foreign material or water from accumulating in the pump.
- Remove all casing and drain plugs to prevent accumulation of water.
- If the pump is supplied with belts and sheaves, loosen the tension on the belts.
- If the pump is supplied with oil lubricated bearings, fill the bearing housing to the top with a 20 weight non-detergent oil and replace the vent. On pumps with grease lubricated bearings, re-grease before storing.
- After inspecting the pump, re-crate the unit and store it in a clean, dry place that is free from extremes in temperature.
- Rotate the pump shaft at least 10 turns every week to prevent pitting and corrosion on the bearing surfaces.

### **Special Tools**

No special tools are required for the installation of your unit.

### **Pump Location**

The pump should be located on a flat, hard surface. The surrounding area should be open to permit easy access for maintenance and service. The pump area should have adequate headroom, sufficient ventilation, and a dry working area.

Before installing your pump, compare the physical location with the dimensions on the outline installation drawing to ensure proper fit. You must determine that the available space is sufficient for the pump, taking into account the following provisions:

- Dimension and weight of the pump package.

- Required moving and hoisting equipment.
- Possible piping layout, including space for removal and maintenance.
- Freedom of movement to operate the unit, read speed and pressure gauges, and provide adjustment and maintenance.
- Space required for lubrication.
- Space for removal of coupling and belt guards.

### **Foundation**

The concrete pump foundation should be 4 inches wider and longer than the pump base. When installing the pump, make sure that the surface of the foundation is rough but free of debris. The foundation should be level and of sufficient depth and strength to adequately support the pump base.

### **Anchor Bolts**

Anchor bolts should be set into the concrete foundation. For best results, use anchor bolts made of corrosion resistant material such as stainless steel. Anchor bolt nuts should be of a different grade stainless steel to prevent galling.

Initially tighten the anchor bolts one eighth of a turn with a wrench. Do not fully tighten until after the pump shafts have been aligned and the pump base has been grouted to the foundation.

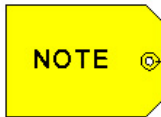

---

---

**Make sure the foundation is clean, free of loose debris, and level. Allow grout to cure for at least two days before fully tightening the anchor bolts.**

---

---

### **Baseplate Grouting**

After the pump has been set in place and leveled, grout the pump through the hole in the base, making sure that no voids or open spaces remain.

### **Piping**



---

---

**All piping to and from the pump must be independently supported. Undue stress on the pump suction or discharge flanges can cause serious injury or equipment failure. The pipe supports should be located as close to the pump as possible.**

---

---

### **Suction Piping**

The pump should be located as near to the liquid source as possible. The suction piping should be at least the same diameter as the suction flange and should have a straight run of pipe that is a minimum of 8 to 10 pipe diameters long. If the piping must make a change in direction, use long radius fittings. Suction piping must be airtight and suitable for both pressure and vacuum.

If the pipe diameter is increased or decreased, use eccentric pipe reducers to eliminate any space in the top of the line where air can accumulate. If possible, run the suction line so that the pump suction flange is the highest point in the line.



An inlet valve should be located near the pump to isolate the unit for service and repair. Never install a check valve on the suction side of the pump. It is recommended that a compound vacuum / pressure gauge be installed to monitor pump performance.

### **Discharge Piping**

The pump discharge piping should be a similar diameter as the discharge flange. Avoid sudden changes in pipe diameter by using concentric taper increasers. Provide as straight of a pipe run as possible after the discharge of the pump. If piping must make a change in direction, use long radius fittings.

A check valve can be installed on the discharge side of the pump, and an isolation valve is required to service the pump. It is recommended that a pressure gauge be installed to monitor pump performance.

### **Isolation Joints**

Elastomeric isolation joints that insulate the pump from vibration and stresses should be installed on both the suction and discharge flanges.



---

**All pipe flanges should be cleaned prior to the installation of isolation joints and pipes. A clean flange will ensure a proper seal. All piping, joints, and valves must be airtight.**

---

## **Service Connections**

### **Stuffing Box Seal**

Fairbanks Morse uses graphite impregnated Teflon braided packing in stuffing box seals unless otherwise specified. This material requires a liquid flush in order to provide cooling and lubrication to the packing. The packing gland housing has two ports to which the flushing fluid can be connected. The second port that is not used can remain plugged or can be piped to a drain. The flushing fluid should be clean and have a lubricating quality.

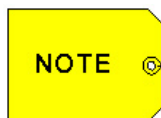

---

**Seal flushing fluid should be at a pressure that is 10-15 PSIG above the maximum discharge pressure of the pump. This will ensure positive flow through the packing gland. The seal flushing fluid flow rate should be set at 0.5 to 1.5 GPM depending on the application and severity of abrasives in the pumped fluid.**

---

An automatic flushing system may be used to ensure that the seal flushing fluid is flowing when the pump starts. The system can consist of a solenoid valve, isolation and bypass valves, an inline visual flow indicator, a throttle valve, a regulator, and a pressure gauge.

### **Mechanical Seal**

If your unit has a mechanical seal, refer to the detailed manufacturer's installation and operating literature. In general, the pump will have either a single or double mechanical seal. In most cases, seal flushing fluid is recommended. The seal typically has a flushing port located on the seal gland plate that delivers the fluid to the seal faces. Remove the plug and pipe the flushing fluid to this connection. The seal fluid should be 10-15 PSIG above the maximum discharge pressure of the pump, and the seal fluid flow rate should be 0.5 to 1.5 GPM.

Since the cast iron gland housing for a mechanical seal and a stuffing box are interchangeable, the housing will still have the two flushing fluid connections as described herein. These should remain plugged.

**Drain Connection**

Fairbanks Morse pumps are equipped with a drain connection on either the bearing housing or the backplate that drains a reservoir designed to collect leakage from the packing gland housing. The drain connection should be piped to the nearest floor drain.

**Field Alignment**

Fairbanks Morse pump packages are initially aligned at the factory. However, due to stress encountered during shipment, the pump alignment must be re-checked in the field prior to startup.



---

---

**Failure to properly align the coupling or belts and sheaves may cause damage to the pump, property, or personnel.**

---

**V-Belt Arrangement**

Loosely assemble the sheaves on the pump and motor shaft. The mating surfaces of the bushing outside diameter and sheave hub inside diameter must be clean and free of all lubricants. Do not tighten the sheaves.

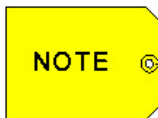

---

**Use no lubricant to install the sheaves on the pump or motor shaft.**

---

Make sure that the shafts are parallel by measuring the distance between them at three or more places. If the shafts are not parallel, adjust as necessary.

Position both sheaves on their shafts as close to the motor or shaft bearing as possible to minimize bearing loads, but allow room for some adjustment. If a variable speed sheave is supplied, adjust its pitch diameter as required. Check the alignment by placing a straight edge or a piece of string across the driver sheave and the driven sheave near their centers. The straight edge should touch each sheave on both sides so that it makes four points of contact. Tighten the motor and pump sheave to eliminate any angular movement. Recheck alignment and adjust the motor sheave as necessary. Rotate the sheaves one half of one turn and recheck. If the sheaves are out of alignment after rotating, the pump or motor shaft may be bent.

Install the belts in the grooves on the sheaves. Tension the belts in accordance with the instructions provided herein.



---

---

**Improperly adjusted sheaves and belts may cause premature belt wear and excessive vibration. This can damage the pump shaft, bearings, or seals.**

---



**Refer to all sheave and belt manufacturer's installation and operation instructions if provided with your unit. The manufacturer's instructions supercede all Fairbanks Morse instructions unless specifically noted.**

---

---

### **Direct Coupled Arrangement**

The pump and driver shafts must be checked for parallel and angular alignment. Parallel alignment should be checked with a straightedge, and angular alignment should be checked with a micrometer, calipers, taper gauge, or a laser alignment tool. Refer to the coupling manufacturer's installation and operation instructions for acceptable maximum allowable misalignment.

### **Belt or Coupling Guards**

Replace the belt or coupling guards after all alignment and adjustment.



**Failure to replace the guards when operating can result in injury and damage to the equipment.**

---

---

## **Operation**



**Operation of your Fairbanks Morse pump involves potentially hazardous procedures. Only trained and qualified personnel who have read and who understand the instructions in this manual, the reference publications, and the supplier manuals shall operate this equipment.**

The following procedures should be used for the safe operation of your pump.

**Pre-Startup Checklist**

All of the following items should be verified prior to startup.

- **ALIGNMENT:** Recheck the alignment as outlined herein.
- **FREE ROTATION:** Turn the pump shaft by hand. The shaft should rotate freely.
- **DEBRIS:** All construction debris should be removed from the suction piping and suction well.
- **GUARDS:** Make sure that all coupling or belt guards are in place.
- **MOTOR:** Prepare the motor as outlined in the motor manufacturer’s installation and operation manual. A motor starter with overload protection should be provided, and proper wire size, fuse size, and other electrical devices should conform to local code and regulation.
- **LUBRICATION:** Oil lubricated pumps may be shipped with or without oil. It is necessary to check the level of the oil through the sight glass or constant level oiler to determine if there is oil in the pump. Before starting the pump, fill the bearing housing with a SAE 20 non detergent oil containing rust inhibitors (Mobil DTE 25 or equal). Operate the pump (**ONLY AFTER FOLLOWING ALL OF THE PROCEDURES IN THIS SECTION**) for two minutes then drain the oil from the housing and refill with fresh oil. Do not operate the pump without lubrication as this will result in bearing failure. Grease lubricated pump bearings are packed at the factory with an NLGI number 2 grease such as Shell Dolium R. The pump bearings should be topped off with 4-5 squeezes from a low pressure grease gun prior to initial operation.
- **SEAL FLUSH – STUFFING BOX:** Before starting your pump, it is necessary to provide seal flushing fluid to the stuffing box four to six hours prior to operation. This will ensure that the packing is fully swelled with lubricating fluid. Initially allow a generous amount of fluid to leak from the back of the packing gland housing – there should be a steady stream. This can be accomplished by loosening the split gland turning the seal fluid on. When you start the pump, adjust the flushing fluid so there is 1-2 drops per second. After the pump runs for four to six hours, adjust the packing gland so that drip rate is approximately 60 drops per minute.
- **SEAL FLUSH – MECHANICAL SEAL:** The mechanical seal requires seal flushing fluid to prevent scoring of the seal faces. Turn on the seal flushing fluid five minutes prior to starting the pump.
- **ROTATION:** Jog the motor to check for rotation. A rotation arrow is cast on the pump case and is also indicated on the pump data sheet. Adjust the motor leads as necessary.

**Startup Checklist**

PROCEDURE	YES	NO	NA	COMMENTS / CONDITIONS
-----------	-----	----	----	-----------------------

<b>IDENTIFICATION</b>				
1. Date of initial operation:	<input type="checkbox"/>	<input type="checkbox"/>	<input type="checkbox"/>	_____
2. Pump model and serial number (from nameplate):	<input type="checkbox"/>	<input type="checkbox"/>	<input type="checkbox"/>	_____
3. Installation site and tag number:	<input type="checkbox"/>	<input type="checkbox"/>	<input type="checkbox"/>	_____
4. Purchase order number:	<input type="checkbox"/>	<input type="checkbox"/>	<input type="checkbox"/>	_____
<b>RECEIVING</b>				
1. Is there any visible damage?	<input type="checkbox"/>	<input type="checkbox"/>	<input type="checkbox"/>	
2. Have all items been received?	<input type="checkbox"/>	<input type="checkbox"/>	<input type="checkbox"/>	
<b>STORAGE</b>				
1. Was equipment stored in a dry area?	<input type="checkbox"/>	<input type="checkbox"/>	<input type="checkbox"/>	
2. Have storage instructions been followed?	<input type="checkbox"/>	<input type="checkbox"/>	<input type="checkbox"/>	
<b>INSTALLATION</b>				
1. Is paint in good condition?	<input type="checkbox"/>	<input type="checkbox"/>	<input type="checkbox"/>	
2. Is piping independently supported?	<input type="checkbox"/>	<input type="checkbox"/>	<input type="checkbox"/>	
3. Are all piping joints leak tight?	<input type="checkbox"/>	<input type="checkbox"/>	<input type="checkbox"/>	
4. Is the foundation level?	<input type="checkbox"/>	<input type="checkbox"/>	<input type="checkbox"/>	
5. Is the base bolted down?	<input type="checkbox"/>	<input type="checkbox"/>	<input type="checkbox"/>	
6. Is the base grouted in position?	<input type="checkbox"/>	<input type="checkbox"/>	<input type="checkbox"/>	
7. Are all bolts and fasteners tight?	<input type="checkbox"/>	<input type="checkbox"/>	<input type="checkbox"/>	
8. Are all service connections properly connected?	<input type="checkbox"/>	<input type="checkbox"/>	<input type="checkbox"/>	
9. Are accessories mounted and operating properly?	<input type="checkbox"/>	<input type="checkbox"/>	<input type="checkbox"/>	
10. Are all guards in place?	<input type="checkbox"/>	<input type="checkbox"/>	<input type="checkbox"/>	
<b>LUBRICATION</b>				
1. Has the proper grade and amount of oil been added?	<input type="checkbox"/>	<input type="checkbox"/>	<input type="checkbox"/>	
2. Is the oil breather installed properly?	<input type="checkbox"/>	<input type="checkbox"/>	<input type="checkbox"/>	
3. Have the motor bearings been greased?	<input type="checkbox"/>	<input type="checkbox"/>	<input type="checkbox"/>	
4. Have the pump bearings been greased (if equipped)?	<input type="checkbox"/>	<input type="checkbox"/>	<input type="checkbox"/>	
5. Has the coupling been lubricated (if required)?	<input type="checkbox"/>	<input type="checkbox"/>	<input type="checkbox"/>	
<b>ALIGNMENT</b>				
1. Has the belt tension been checked?	<input type="checkbox"/>	<input type="checkbox"/>	<input type="checkbox"/>	
2. Have the sheaves been aligned?	<input type="checkbox"/>	<input type="checkbox"/>	<input type="checkbox"/>	
3. Has the direct coupling been checked (if required)?	<input type="checkbox"/>	<input type="checkbox"/>	<input type="checkbox"/>	
4. Have the shafts been checked with an indicator (direct coupled)?	<input type="checkbox"/>	<input type="checkbox"/>	<input type="checkbox"/>	
<b>ROTATION</b>				
1. Does the shaft turn freely by hand?	<input type="checkbox"/>	<input type="checkbox"/>	<input type="checkbox"/>	
2. Has the seal flushing fluid been turned on?	<input type="checkbox"/>	<input type="checkbox"/>	<input type="checkbox"/>	
3. Are the flushing fluid flow and pressure adequate?	<input type="checkbox"/>	<input type="checkbox"/>	<input type="checkbox"/>	
4. Is the shaft rotation correct?	<input type="checkbox"/>	<input type="checkbox"/>	<input type="checkbox"/>	
<b>OPERATION</b>				
1. Does the pump operate smoothly?	<input type="checkbox"/>	<input type="checkbox"/>	<input type="checkbox"/>	
<b>ELECTRICAL DATA</b>				
Motor Manufacturer:		Operating Amperage	Operating Voltage	
Nameplate Horsepower:		L1-L2:	L1-L2:	
RPM:		L2-L3:	L2-L3:	
Nameplate Voltage / FLA:	/	L1-L3:	L1-L3:	
<b>SYSTEM DATA</b>		Point 1	Point 2	Point 3
Pumped Fluid:		Suction Pressure:		
Temperature:		Discharge Pressure:		
Specific Gravity:		Pump Speed:		
Percent Solids:		Flow Rate:		
<b>SIGNATURES</b>				
Representative Name:		Contractor Name and Date:		
Company:		Contractor Signature:		
Phone:		Owner's Name and Date:		
		Owner's Signature:		

## Turning the Pump On



**The risk of exposure to electrical hazards must be eliminated. Be sure that the wiring, connections, and other electrical devices are operating properly.**

---



---



**All guards and safety devices must be installed prior to operating the pump.**

---

Once all of the items in the Pre-Startup Checklist have been verified, follow the following procedure to start the pump.

- Turn on the seal flush system.
- Fully open the suction valve and flood the pump with liquid. A positive suction head is desired. If the pump must pull from suction, prime the pump.
- Engage the motor.
- Immediately open the discharge valve.
- If there are any loud or unusual noises, immediately turn the pump off.

### Operating the Pump

The following section provides details on the safe operation of your pump.

#### Pressure Measurement

The suction and discharge pressure should be measured to verify that the pump is operating at its design point as specified on the pump nameplate or in the pump data sheet.



**Failure to operate at the design point can cause excessive vibration, increased motor amperage draw, and increased wear of the wetted parts.**

---

#### Motor Amp Draw

The current required by the pump motor will vary for different applications. In general, the pump is designed to operate from 50% to 95% of the full load amps stamped on the motor nameplate. Using an accurately calibrated amprobe, check all three phases of the motor and record.

**Immediately** report abnormal amperage to site management. If the pump motor is pulling normal current, recheck it 30 minutes after you start it. This allows the motor sufficient warm-up time. The reading you obtain should be the reading of the unit's normal operating range. **DO NOT** operate the pump motor above the full load amperage stamped on the motor nameplate.

## **Power Supply Voltage**

Standard voltage offered by motor manufacturers is typically 230/460 volt. Since it is unlikely that your voltage is exactly standard, motor manufacturers allow a  $\pm 10$  percent variation in the operation of their motors. This variation can be tolerated on all voltage variations at the rated frequency. **Both the motor manufacturer and Fairbanks Morse are not responsible for motor failure due to the use of incorrect voltage.** Also, neither is responsible for motor failure due to unbalanced voltage of the three phases. If you have a high, low, or unbalanced voltage problem, correct it before connecting any motors to it.

## **Throttling**



---

---

**Never throttle the pump on its suction side. This will cause damage. Do not operate the pump against a closed discharge valve.**

---

---

The discharge valve may be throttled to provide variable capacity. The suction side of the pump should remain open and free of obstruction.

## **Pump Speed**

The pump speed should be measured after the first four to six hours of operation to ensure that the speed is set correctly and has not changed.

## **Turning the Pump Off**

The following procedure should be followed to stop the pump.

- Close the discharge valve to prevent backflow.
- Immediately de-energize the motor.
- Isolate any seal flushing fluid connections.
- Close the suction valve.
- If the pump is out of service for more than two weeks, refer to the storage instructions herein.

## Maintenance



---

**Maintenance and repair of your Fairbanks Morse unit involves potentially hazardous procedures. Only trained and qualified personnel who have read and who understand the information presented in this manual, the reference publications, and the supplier manuals shall maintain and repair this equipment.**

---

Your Fairbanks Morse pump is designed to operate efficiently with very little maintenance. However, as with any equipment, malfunctions can occur. To keep your unit running well, preventive maintenance is essential.

### General Preventative Maintenance

Check the following items in the intervals listed below:

- Check gauges on pump suction and discharge and pump operating speed to confirm operating point **(every 3 months)**.
- Check bearing temperature and compare with earlier readings **(every 3 months)**.
- Listen for metal to metal scraping sound or other odd noises **(every 3 months)**.
- Adjust packing or mechanical seal as necessary **(every 3 months)**.
- Run an amperage reading to verify that the motors are running normally **(every 6 months)**.
- Inspect the fan guard and remove any accumulated debris from under it and around the motor **(every 6 months)**.
- Tighten any fasteners that may be loose **(every 6 months)**.
- Check shaft sleeve under packing for wear **(every 6 months)**.
- Check shaft for runout and straightness **(every 6 months)**.
- Check the pump alignment and adjust the belts or coupling as necessary **(every 6 months)**.
- Inspect the impeller, case, suction flange, and wearplate for wear **(every 12 months)**.
- Lubricate the motor as listed herein.
- Lubricate the pump as listed herein.

### Motor Maintenance and Lubrication

Lubricate the motor every six months. Most motors have a grease fitting for grease-through lubrication. This fitting is found on the outer frame of the motor at both the top and bottom motor bearings. Just opposite (90 degrees) from the fitting is the relief plug. This may be a spring-loaded, pressure-relief plug that does not need to be removed before lubrication.

Use the following grease to lubricate the motor:

- Shell Dolium R (recommended)
- Standard of California Chevron SRI-2

When lubricating, clean the tip of the fitting and snap the grease gun onto the zerk fitting. Apply grease as follows:



Motor Frame Size	Pumps from Gun
Through 254	1-2
254-365	2-3
365 plus	3-4

**Table 1: Motor Grease Quantity**

**Never over-grease the bearings.** After applying the recommended amount of grease, remove the gun and clean it.

### **Belt and Sheave Maintenance**

Check the alignment of the belts and sheaves as outlined herein. To install the belts, shorten the center distance between the driven and driver sheaves. Lay the belts into the sheave grooves without the use of force. While the belts are still loose on the drive, rotate the drive by hand until the slack is evenly distributed on both sides. Increase the center distance until the belts are snug. The drive can then be tensioned.



**Never roll or pry the belts into the sheave grooves. This can damage the belt cords and lead to belt turnover, short life, or actual breakage. It is unsafe to install belts this way.**

---

---

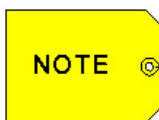

**Keep take-up rails, motor bases, and other means of center distance adjustment free of dirt, rust, and grit. Lubricate adjusting screws and slide rails from time to time.**

---

---

Operate the drive for five minutes to seat the belts in the sheave grooves. Observe the operation of the drive under its highest load condition, usually on startup. A slight bowing of the slack side of the drive indicates proper tension. If the slack side remains taut during the peak load, the drive is too tight. Excessive bowing or slippage indicates insufficient tension. If the belts squeal as the motor starts or at some subsequent peak load, they are too loose and can not deliver the required torque. The drive should be stopped and the belts should be tightened.

Check the tension on a new drive frequently during the first day of operation by observing the slack side span. After several days of operation the belts will seat themselves in the sheave grooves. It may be necessary to readjust the drive at this time.

### **Direct Coupling Maintenance**

The direct coupling should be aligned as indicated herein. Inspect the coupling periodically for signs of wear.

### **Pump Bearing Lubrication - Oil**

Oil lubricated pumps require a **SAE 20 non detergent oil containing rust inhibitors (Mobil DTE 25 or equal)**. The oil should be changed every four to six months, depending on duty cycle and ambient conditions.

When changing oil in the pump bearings, refill to the center line of the site glass when the pump is at rest.  
Approximate volume is: Model CE – .60 quarts

A contact type or immersion thermometer mounted on the bearing housing can be used to measure the bearing temperature. Do not test by hand, as the pump case may be hot. Normal bearing temperatures can be anywhere from 90°F to 170°F, depending on ambient conditions. Oil lubricated bearings can be safely operated up to 200°F. A change in temperature may indicate damage that requires attention.

### **Pump Bearing Lubrication - Grease**

Grease lubricated pump bearings require an **NLGI Number 2 grease such as Shell Dolium R or equal**. The bearings should be greased every four to six months, depending on duty cycle and ambient conditions. Use a low pressure grease gun to pump grease into the zerk fitting until grease can be seen exiting from grease relief. If your pump was shipped without grease fittings, remove the plugs and replace them with a zerk fitting and spring loaded grease relief.

When rebuilding the pump or replacing the bearings, pack the bearings with grease prior to installing the shaft in the bearing housing.

### **Wet End Maintenance**

The wet end of the pump, which generally consists of the impeller, wearplate, suction flange, and case, does not require any maintenance. These parts should be inspected periodically to prevent unforeseen problems.

If you find that your parts are wearing excessively, Fairbanks Morse offers a wide variety of materials with enhanced abrasion resistance. Our premier Super XT Ni-Hard provides maximum abrasion resistance.

## 4600CE - Assembly and Disassembly



**Close all valves before and after the pump to isolate the unit. If applicable, isolate seal water. Lock out the unit to ensure that the pump does not start while working on it. Turn off all power to the pump motor. Drain the oil from the pump.**

### 4600CE Exploded View

The exploded view contains part reference numbers that are used in the assembly and disassembly procedure.

Item	Description	Item	Description	Item	Description
1	Case	11	Shaft Sleeve	22	Sleeve Gasket (O-Ring)
2	Impeller	12	Split Gland	23	Bearing Cap Gasket
4	Bearing Housing	13	Lantern Ring*	24	Case Gasket (O-Ring)
5	Wearplate	15	Thrust Bearing	28	Packing Ring*
6	Backplate	16	Radial Bearing	31	Shaft Key
7	Bearing Cap	17	Oil Seal	32	Collet
9	Shaft	20	Snap Ring	78	Sleeve Drive Key
10	Lockscrew, Impeller	21	Slinger		
				*	Not shown

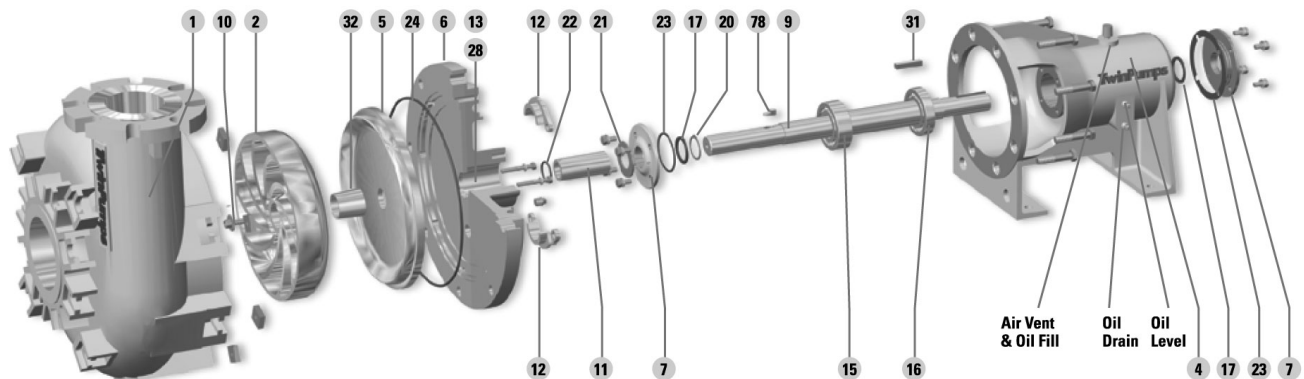

## **Disassembly Procedure**

The following procedure should be used to disassemble the pump.

### **Rotating Assembly Removal – Back Pull Out Design**

The case may be left in place if service is to be performed on the shaft, sleeve, impeller, bearing frame, or shaft seal.

- Support the case independent of the piping so that no force is transferred from the piping to the case. Undue stress on the suction or discharge flanges may cause the case to crack. The case may be supported by blocking underneath with wood or by slinging with an overhead hoist.
- Remove the coupling or belt guard. Remove the motor coupling or belt pulley from the pump shaft.
- Unbolt the pump from its base.
- Remove the case bolts from the back of the case to free the bearing frame (No. 4). The pump can now be lifted from the base.

### **Impeller Removal**

- Remove the set screw from the impeller bolt (No. 10). The set screw may be difficult to remove since it is installed with thread locker. You may need to apply heat to break the bond.



**The impeller will be free once the impeller bolt is removed. Take the necessary precautions to prevent the impeller from falling.**

---



---

- Loosen the impeller bolt (No. 10), but do not remove. Again, heat may be required as the bolt is installed with red permanent thread locker.
- The impeller (No. 2) is held in place with the pressure of the locking collar on the collet (No. 32). Two 5/8"-11 threaded jacking holes are provided on the bearing frame to help with the removal of the impeller. Insert two bolts into the jacking holes and tighten. This will push the backplate and wearplate against the back of the impeller. Tighten until the impeller is loose.
- Once loose, remove the impeller bolt and remove the impeller from the shaft and collet.



**The wearplate will be free once the collet and impeller are removed. The wearplate is sandwiched in place between the backplate and the impeller. Support the wearplate so that it does not fall.**

---



---

### **Wearplate Removal**

- Remove the collet (No. 32) from the shaft.
- Once the collet is removed, slide the wearplate off of the shaft.
- Remove and discard the case gasket o-ring (No. 24).

---

## Backplate and Packing Gland Housing Removal

---

**NOTE** 

**The backplate and packing gland are a single piece casting.**

---

- For PACKING ARRANGEMENT: Loosen and remove the split gland (No. 12) from the packing gland housing (No. 6). For MECHANICAL SEAL ARRANGEMENT: Loosen and remove the seal per the manufacturer's recommendation.
- Remove the lantern ring and packing from packing gland housing if so equipped. These parts may also be removed with the backplate and packing gland as well.
- Slide the backplate and packing gland forward off of the bearing frame (No. 4).

### Shaft Sleeve Removal

- Remove the shaft sleeve gasket o-ring (No. 22) from the shaft (No. 9).
- Slide the shaft sleeve towards the impeller end of the shaft and remove.
- Remove the sleeve drive key (No. 78) and the slinger (No. 21) from the behind the sleeve.

### Shaft and Bearing Removal

---

**NOTE** 

**Drain the oil from the pump and dispose of it consistent with all regulations.**

---

- Remove the inboard bearing cap (No. 7). The oil seal (No. 17) will come off with the bearing cap along with the inboard bearing cap shim (No. 23).
- Remove the outboard bearing cap (No. 7) from the coupling end of the pump. The oil seal and the outboard bearing cap shim (No. 26) will come off with the bearing cap.
- Make sure there are no obstructions on the impeller end of the shaft to prevent the removal of the shaft. Using a soft mallet or a deadblow with a block of wood, knock the shaft out of the bearing housing from the drive end of the pump toward the impeller end of the pump. Be careful not to damage the bearing bores on the bearing housing.
- Using a press, carefully remove the bearings from the shaft and discard them.

**NOTE** 

**Do not reuse bearings that have been pressed off of the shaft. The forces encountered during this operation will likely damage the balls or races.**

---

## Case Removal

---



**The suction and discharge piping must either be removed or supported when changing or servicing the case. Be sure to follow safe rigging procedures, as these components are very heavy and can cause injury.**

---

Remove the suction and discharge piping to gain access to the case. Unbolt and remove the case.

### Cleaning and Inspection

- Discard all used seals, gaskets, o-rings, and worn parts.
- Thoroughly clean all parts with an approved solvent and inspect for damage or wear. Replace all bearings, gaskets, washers, shims, worn parts, and hardware as necessary.
- 

### Assembly Procedure

The following procedure should be used to assemble the pump.

### Pre-Assembly Inspection

- Inspect all existing parts and replacement parts and make sure all are clean and undamaged. Parts that should be replaced as part of a complete pump rebuild include bearings, oil seals, bearing cap shims, all gaskets, o-rings, and any other item that is worn or damaged.
- Inspect the bearing bores on the bearing housing to make sure they are within tolerance. Bores should be round and without grooves or other signs of wear.
- Make sure the bearing housing is free of dirt, filings, or other debris. An unclean bearing housing will greatly reduce the life of the bearings.

### Bearing Assembly

- Heat the bearings in an oil bath or with an induction heater to 185°F.
- Inspect the shaft and bearing races for burrs and remove as required. Coat the shaft with a light lubricating oil and slide on the hot inboard bearings followed by the outboard bearings. The bearings should slip easily on the shaft. Do not press the bearings on the shaft.

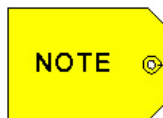

**The inboard bearing arrangement is critical. The external snap ring must be positioned so that it is closest to the impeller end of the shaft. The outboard arrangement is not critical.**

---

- All bearings should be seated against the shoulder of the shaft.
- Inspect the bearings and make sure that all rotate freely.

## Shaft Assembly

- Coat the outer races of the bearings and the inner diameter of the bearing housing bores with a light lubricating oil. Make sure there is no dirt or debris on either the bearings or the bearing housing bores.
- Slide the shaft into the pump from the front making sure that the inboard bearings engage the bearing housing bore flush and straight. Tap the impeller end of the shaft with a soft hammer or deadblow with a piece of wood and slide the shaft and bearing assembly into the bearing housing.



**Do not force the shaft and bearings into the bearing housing!  
This may cause damage to the bearings.**

---

- You may find it easier to install the shaft and bearings when the bearing frame is set on end and the shaft is dropped vertically into the bearing frame. You will have to block the bottom of the bearing frame up off of your working surface to allow the shaft to drop through the end of the housing.
- Tap the shaft and bearings into the housing until it sets against firmly against the shoulder of the housing.

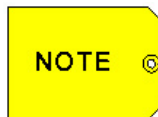

**The following alternate installation method may be used for bearing and housing fits that are tight.**

---

- Set the shaft with bearings into the bearing frame that has been stood on end. Take at least two suitable pieces of all-thread with nuts and thread into the bearing cap holes on the bearing frame at 180° apart. Place the bearing cap over the bearing and evenly tighten the nuts on the all-thread, drawing the bearings into the housing. This will prevent any shock or impact to the balls and races of the bearings. Tighten the all-thread until the bearings are firmly seated into the housing. Remove the all-thread and replace with the bearing cap nuts and washers.

## Bearing Caps Assembly

- Press a new oil seal (No. 17) into the inboard and outboard bearing caps (No. 7).
- Place a bead of RTV silicone sealant on the inboard bearing cap.
- Coat the inboard oil seal surface and the shaft with a light lubricating oil. If the oil seal is equipped with a tensioning spring, make sure that the spring stays in place during assembly.
- Replace the Teflon inboard bearing cap gasket (No. 23).
- Tighten the inboard bearing cap into place.
- Coat the outboard oil seal surface and the shaft with a light lubricating oil. If the oil seal is equipped with a tensioning spring, make sure that the spring stays in place during assembly.
- Replace the plastic outboard bearing cap gasket (No. 23).
- Tighten the outboard bearing cap into place. No additional adjustment is required.
- Make sure that the shaft rotates smoothly.

## Packing Gland and Shaft Sleeve Assembly – Stuffing Box

- On pumps equipped with a stuffing box seal, set the packing gland housing (No. 6) on a flat surface and place the shaft sleeve (No. 11) in the center of the stuffing box bore. Make sure that the sleeve is facing the correct position.
- Leave the shaft sleeve in place and insert the first ring of the packing set (No. 28) until it sits flush on the shoulder on the bottom of the packing gland. Follow the packing order as shown in the following table. Insert the split Teflon lantern ring (No. 13) as indicated on the chart. Stagger the ends on both the packing rings and the lantern ring.

Pump Size	Packing Order	Packing Size
2 inch	2 rings – lantern – 3 rings	3/8" square – 6-5/8" long
3 inch	2 rings – lantern – 3 rings	3/8" square – 6-5/8" long
4 inch	2 rings – lantern – 3 rings	3/8" square – 6-5/8" long
6 inch	2 rings – lantern – 3 rings	3/8" square – 6-5/8" long

**Table 2: 4600CE Packing Arrangement and Size**

- Place the slinger (No. 21) on the shaft.
- Once the packing and the lantern ring are installed in the packing gland housing, ensure that the shaft is free of debris and burrs. Coat the shaft with a never-seize compound.
- Place the shaft drive key (No. 78) on the shaft.
- Line up the key slot on the shaft sleeve with the shaft drive key groove on the shaft and slide the entire packing gland housing with shaft sleeve onto the shaft. Bolt the gland housing and backplate in place.
- Install the split gland (No. 12) with the stainless steel studs, washers, and nuts.
- Adjust new packing as outlined herein .

## Packing Gland and Shaft Sleeve Assembly – Mechanical Seal

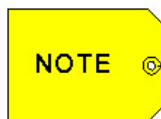

**The order of this procedure may be different depending upon the type of mechanical seal in your pump. Study the seal manufacturer's installation manual before proceeding.**

- On pumps equipped with a mechanical seal, place the slinger (No. 21) on the shaft.
- Ensure that the shaft is free of debris and burrs. Coat the shaft with a never-seize compound.



- Line up the key slot on the shaft sleeve with the shaft drive key groove on the shaft and slide the entire packing gland housing with shaft sleeve onto the shaft. Bolt the gland housing and backplate in place.
- Install the mechanical seal per the manufacturer's recommendations.

### Wearplate Installation

- Place a generous bead of grease along the backside of the wearplate (No. 5). The grease will act as a temporary adhesive and will make the final installation steps much easier.
- Press the wearplate on the backplate so that the grease helps support the wearplate.

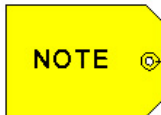

---

---

**The wearplate is sandwiched in place between the case and the backplate. There are no fasteners that hold it in place.**

---

---

### Impeller Installation

- Inspect the shaft and make sure that it is free of nicks or burrs. Inspect the impeller bore for signs of wear.
- Place the collet (No. 32) on the shaft so that it butts against the sleeve. The collet taper and the impeller taper must match.
- Fairbanks Morse supplies impellers that are balanced. This is critical to trouble free operation.
- Align the impeller on the shaft and slide the impeller in place.
- Clean and degrease the impeller bolt (No. 10) and coat with permanent thread locker. Tighten the impeller bolt onto the shaft at the values listed below:

Pump Size	Torque (ft-lbs)
2 inch	150
3 inch	150
4 inch	150
6 inch	150

**Table 3: 4600CE Impeller Fastening Torque Values**

- Coat the impeller bolt set screw with permanent thread locker and install in the hole provided on the impeller bolt.

### Case Installation

- Remove all old gaskets and clean the surface of the case and the backplate. Install a new case gasket o-ring (No. 24).
- Install the bolts and nuts, making sure that the case is centered. It may be necessary to hold the case in place with an overhead hoist.



**Do not over-tighten the case bolts! Undue stress on the T-slots on the case can crack the casting. The case is constructed of a hard and brittle material.**

---

- Tighten the case bolts with a torque wrench to 25 ft-lbs in a star pattern. When you get back to the first bolt, increase the torque to 40 ft-lbs and repeat.
- Reconnect piping and service connections. Lubricate the pump as listed herein.

**THIS PAGE INTENTIONALLY LEFT BLANK**

**THIS PAGE INTENTIONALLY LEFT BLANK**