



IntelliBoost 3.0

Basic Operation of Pump Controller

TABLE OF CONTENTS

Description	Page
Basic Operation of Pump Controller.....	1
VFD Parameters and Communication Setting.....	1,2
PLC Screens	3-10
Home	3
Menu	3
Password Entry - Basic	3
Basic Setup 1	3
Basic Setup 2	4
Basic Setup 3	4
Basic Setup 4	4
Basic Setup 5	4
Digital Input Setup	5
Input Alarm Configurations	5
Relay Output Setup	5
Relay Output Options	5
Maintenance Alarms	6
Communication	6
Drives	6
Alarm History and Faults	7
Advanced Menu	7
Password Entry - Advanced	7
Set Hardware	7
Speed Max/Min	8
Set Start/Stop	8
Ramp Speed	8
Auto Setup	8
Start Lead	9
Discharge	9
Suction	9
Password Disable/Enable	10
Controller Specifications with Options	10
Modbus Bridge Access Map	11

Basic Operation of the Pump Controller

Multiple Pump Controllers -maximum (4) VFD's:

The controller will have a power OFF/ON selector switch to power up system. The normal operation of the controller as well as the staging of the pumps is controlled by an independent processor. The VFD(s) act as "signal follower" and do not independently control the speed of the pumps in "Auto On" mode. For initial setup and in the event of a system failure, the VFD(s) can run the pumps in "Hand On" control at a user selected fixed speed, ignoring all signals from the pump controller.

VFD Operation:

2-4 drives operate in the same manner. Hand On, Off, Auto On and Reset is the basic operations for the Local Control Panel. "Hand On" selection required for independent drive manual operation. Off will turn off VFD, stopping pump rotation. Auto On is selected when PLC is ready for testing and operation. Reset in case of VFD fault, refer to operation manual.

VFD Parameters and Communication Settings:

VFD parameters set as described below should be entered when VFD is in the Off position. PLC and VFD are master slave configured using Mod Bus RTU communication. Loss of communication will stop drive after Timeout. Each drive shares same parameter set except where drive name is required (Drive1 = 2, Drive2 = 3, Drive3 = 4, Drive4 = 5). A Master Local Control Panel, LCP, is used to Copy and Download parameters from VFD to VFD.

Parameters:

Refer to following page for Parameter Settings.

PARAMETER	DESIGNATION	DEFAULT
0-01	Language	US English
0-02	Motor Speed Units, RPM or Hz	Hz
0-03	Regional Settings	North America
1-03	Torque Characteristics	Auto EnergyOptim VT
1-23	Motor Frequency	Nameplate
1-24	Motor Current	Nameplate
1-25	Motor Speed	Nameplate
3-03	Maximum Reference	60Hz
3-41	Ramp Up Time	2 sec.
3-42	Ramp Down Time	2 sec.
4-14	Motor High Speed Limit	60Hz
4-19	Maximum Output Frequency	60.1Hz
4-12	Motor Speed Low Limit	0Hz
5-12	Terminal 27	No Operation
8-01	Control Site	Control Word Only
8-03	Control Time Out	Limit 3.0 sec.
8-04	Control Time Out Function	Stop
8-10	Control Word Profile	FC Profile
8-30	Protocol	Modbus RTU
8-31	Addresses	Drive1 = 2, Drive2 = 3, Drive3 = 4, Drive4 = 5
8-32	FC Port Baud Rate	19200
8-33	Parity	Even Parity, 1 Stop Bit
8-42	PCD Write, Configuration:	[0], [1685] FC Port CTW 1 [1], [1686] FC Port Ref 1
8-43	PCD Read, Configuration:	[0], [1603] Status Word [1], [1603] Main Actual Valve [2], [1614] Motor Current [3], [1618] Motor Thermal [4], [1500] Operating Hours [5], [1501] Running Hours [6], [1610] Power [KW] [7], [1634] Heatsink Temp [8], [1502] Kwh Counter [9], [1692] Warning Word [10], [1693] Warning Word 2 [11], [1690] Alarm Word [12], [1691] Alarm Word 2 [13], [1612] Motor Voltage [14], [1616] Torque (Nm)
8-50	50 Thru 56	Bus
0-50	LCP Copy	All To LCP – After Drive successfully programmed
0-50	LCP Down Load	Download all from LCP – Use existing LCP, download to drive

BASIC DESCRIPTION AND OPERATION OF BOOSTER CONTROLLER

Normal Operation (Auto On - VFD)

The Pump Controller receives a system pressure signal from the Discharge Pressure Transducer. The signal is compared to the Set point and the pump(s) speed is adjusted.

Set point: Desired system pressure.

Minimum Set point: Desired minimum system pressure.

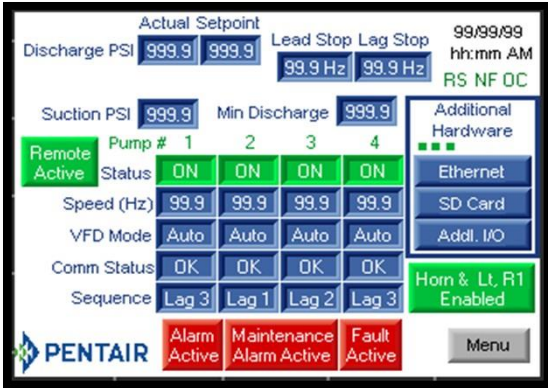

Home: Default Screen on power-up. Shows real-time system operation, status, settings and hardware. Horn & Lt Enable/Disable and active Alarms can be viewed and reset. PLC screen operates with touch response. Flashing Green = Optional Active Communication. RS = Ramp Speed, limits speed when Red. NF = No Flow, when Red. OC = Overcurrent/Minimum Suction, when Red. Remote Active displays when Remote operation is turned on. Continue to Setup: Touch Menu on screen.



Menu = the base of navigation. May be Password Protected, refer to Basic Setup 4.

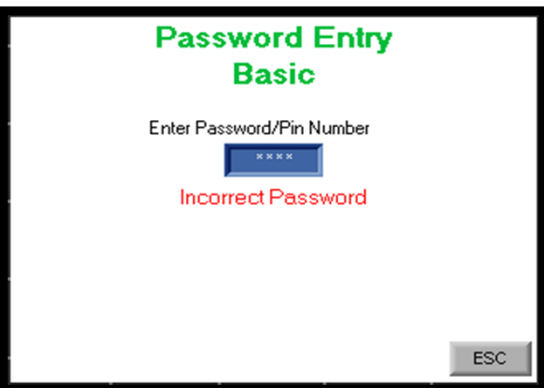

If activated, Password Entry Basic screen will display when Menu button touched. When correct Pin is entered, Menu screen will display. If incorrect, returns to screen with message "Incorrect Password". Reenter correct Pin or ESC.

See Password Disable/Enable Set Password/Pin Number screen.

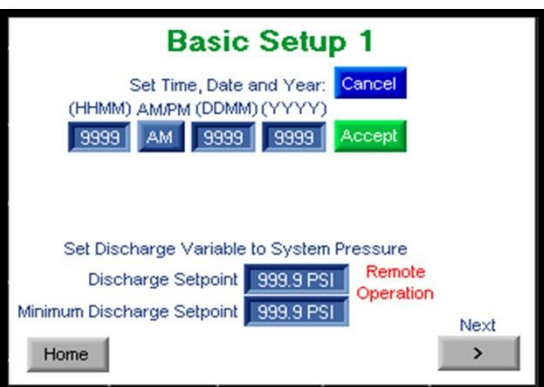

Basic Setup screens need to be completed by Factory and/or End User before operation.

To set Time, Date and Year - Touch SET, enter information.

Set Discharge and Minimum Discharge Set points.

Minimum Discharge Set point - Minimum system allowable pressure

BASIC DESCRIPTION AND OPERATION OF BOOSTER CONTROLLER

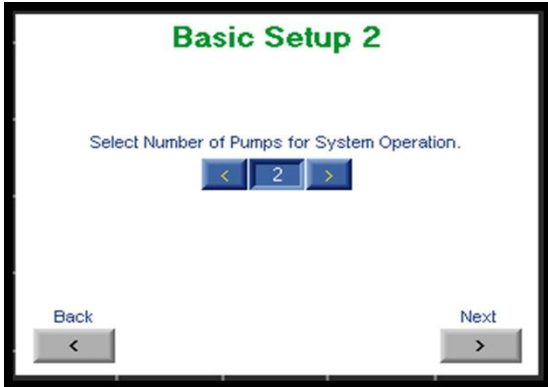

Select number of pumps to be operated by Controller.

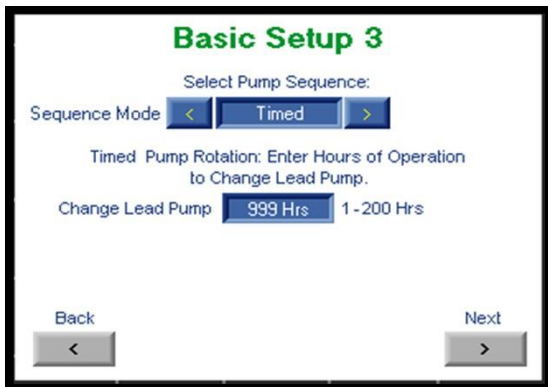

Timed Pump Rotation by Hours of Operation: Lead pump will rotate on every start and changes to next lead pump when continuous Hours of Operation Timed is timed out. Lag pump turns on and off as called for.

Same Lead Pump for all Starts: Same Lead pump turns on for every start. If Lead pump is disabled in anyway, Lead Pump will shift to next available pump. Lag pump turns on and off as needed.

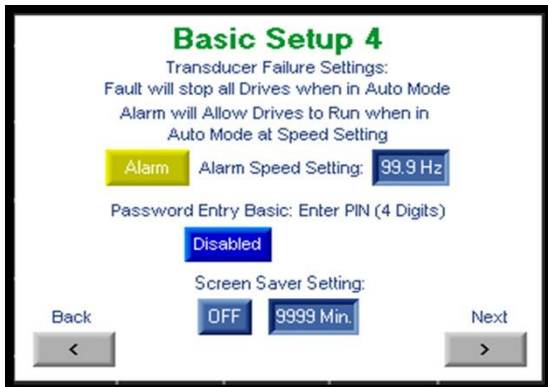

Transducer Failure Settings, when in Auto mode: Select Alarm or Fault. Alarm allows continued operation when system is in Auto Mode, will run at Speed entered in Setting. If no flow detected, drives will stop. Periodic starts will determine if flow is established. Fault will stop all drives.

Password Setup: When Enabled, enter up to (4) numbers to be stored as Password/Pin.

Screensaver: When ON, input mins of inactivity (minimum 2mins).

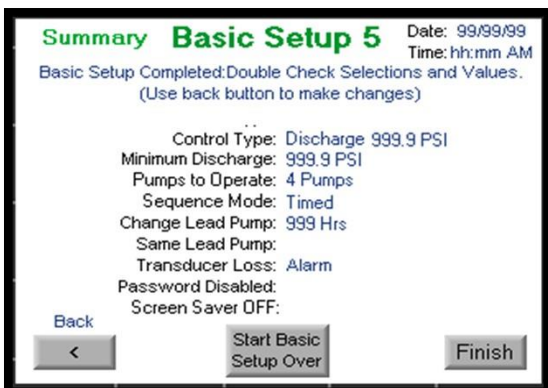

Review Selections. If need adjusting, use Back or Start Basic Setup Over button. Press Finish when done.

BASIC DESCRIPTION AND OPERATION OF BOOSTER CONTROLLER

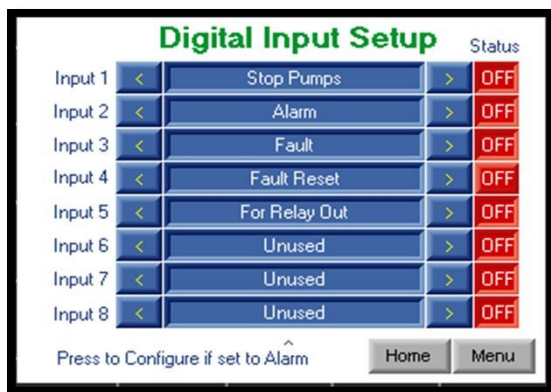

DC signal supplied by controller. Inputs selectable as: Unused, Alarm, Fault, Fault Reset or For Relay Out. Input 1 may be selected to Stop Pumps. 4 Inputs standard, additional 4 can be added as an option. See IntelliBoost Electrical Drawing

If Alarm is selected, press Alarm Button to configure. Input Alarm Configuration screen will display. See Input Alarm Configuration screen.

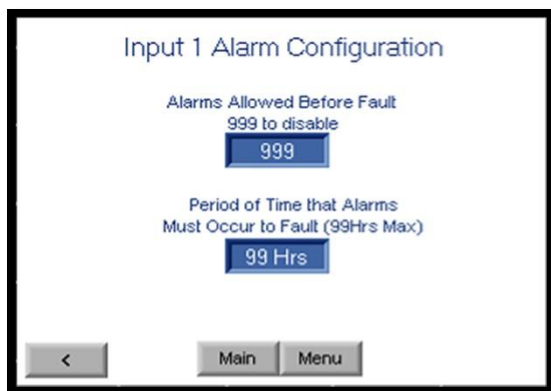

Once alarm has been pressed from previous screen, continue with configuration. Setup Input 1,2,3,4 will allow multiple alarms to cause a fault. Inputs 5-8 Alarm Configuration allowed, if available.

Alarms are recorded. Number of Alarms is a set value not to be exceeded. If exceeded within a set time period, a Fault will occur and system will stop operating. Fault restart requires Operator assistance. Fault must be cleared or disabled for continued operation.

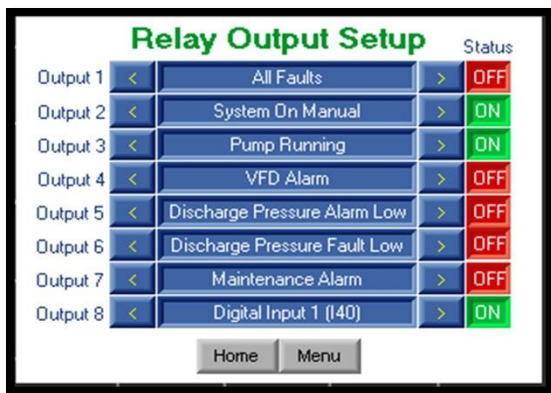

The output relays are form C contacts rated 240Vac 6A. 4 Relay Outputs are standard, additional 4 can be added as an option. See IntelliBoost Electrical Drawing

Relay Outputs can choose to indicate:

- | | |
|--------------------------------------|-------------------|
| System On Auto | Flow Alarm High |
| System On Manual | Flow Fault High |
| Pump Running | All Alarms |
| VFD Alarm | All Faults |
| Discharge Pressure System Alarm Low | Digital In 1 |
| Discharge Pressure System Fault Low | Digital In 2 |
| Discharge Pressure System Alarm High | Digital In 3 |
| Discharge Pressure System Fault High | Digital In 4 |
| Suction Pressure System Alarm Low | Digital In 5 |
| Suction Pressure System Fault Low | Digital In 6 |
| Suction pressure System Alarm High | Digital In 7 |
| Suction pressure System Fault High | Digital In 8 |
| Flow Alarm Low | Maintenance Alarm |
| Flow Fault Low | |

BASIC DESCRIPTION AND OPERATION OF BOOSTER CONTROLLER

Alarm Setting	Pump 1	Pump 2	Pump 3	Pump 4
Starts	0	0	0	0
Alarm Default	10000	10000	-1	-1
T # of Starts	0	0	0	0
Pump Hours	0	0	0	0
Alarm Default	2000	2000	-1	-1
Total Hours	0	0	0	0
Motor Hours	0	0	0	0
Alarm Default	4380	4380	-1	-1
Total Hours	0	0	0	0
VFD Hours	0	0	0	0
Alarm Default	4000	4000	-1	-1
Total Hours	0	0	0	0

Set Default to -1 to Disable Alarm >

Alarm Setting	Set Default to -1 to Disable Alarm	
Pressure Transducer Hours	104	
Discharge Alarm Default	8760	
Total Hours	104	
Pressure Transducer Hours	104	
Suction Alarm Default	8760	
Total Hours	104	
Flow Transducer Hours	0	
Alarm Default	8760	
Total Hours	0	
PLC Hours	104	
Alarm Default	49056	
Total Hours	104	

< Menu Home

Equipment Maintenance Alarm based on Hours of Operation and Starts. To disable Alarms, enter -1 at Default.

Maintenance Alarms indicated and Reset on Home screen.

Maintenance grouped:

First line - Number of operations/hours. Zeros upon Alarm reset.

Second line - Default setting for Maintenance Alarm.

Third line - Total accumulation. Can't be modified.

An alarm is activated when First line's number equals or exceeds Alarm Default. A marker will appear at the default when alarm activates on the Maintenance Alarm screen. A Maintenance Alarm will be flashing on Home Screen. If alarm in Alarm Group is acknowledged, then Maintenance Alarm will stop flashing and number (counts) will stay active. If alarm is reset, then the number or counts will be reset to zero. Default will stay the same and Total will continue to accumulate throughout the life of PLC.

Defaults can be modified.

Alarm records can be retrieved in Fault and Alarm History.

Communication

Web Server/Bridge Access:
IP Address: . . .

Subnet Mask: . . .

Default Gateway: . . .

Activate IP

PLC Name:

RS 485 ID:

Warning:
Copy application overwrites
existing memory locations
and settings in SD or PLC

TO SD CARD TO PLC

Remote Operation:

Active Communication:
 Web Server
 ModBus IP
 ModBus Serial

COM – Optional functions: SD Card and Ethernet with Web Server:

SD Card: Can copy Settings and Values from PLC to SD Card or saved Values on SD Card to PLC.

Webserver: Ethernet Web Server, SD Card included and must be in installed in the Controller for operation.

Remote Operation - Enable/Disable via Modbus Control.

Ethernet, Port 3, if available: Modbus IP Bridge Access.

PLC Name - If Network requires.

RS 485 ID - Modbus Bridge Access.

Active Communication - Flashing Green = Active.

Drive 1

Reset Fault Drive Tripped

Drive OK

Running Speed 99.9 Hz

Output Current 99.99 A

Output Power 9.99 kW

Drive Temp 99 Deg C

kV Hours 9999.9

Run Hours 99999

Operation Hours 99999

VFD Local Control Panel must be in Auto for HMI Remote Control Operation

Transducer Failure

Manual Speed Setting when HMI Man Control ON, VFD ON

99.9 Hz

Man Control Drive OFF/ON

OFF ON

OFF ON

Real-time Drive information and Controls. HMI Drive controls allow basic drive operation without using the Local Control Panel at VFD. Drive screens monitors basic Drive Parameters, Speed in Hz, and VFD On/Off. VFD must be in Auto Mode for this screen operation. On Auto Test and on Transducer failure this screen will go into Manual Control.

6

BASIC DESCRIPTION AND OPERATION OF BOOSTER CONTROLLER



Complete history of all Alarms and Faults.

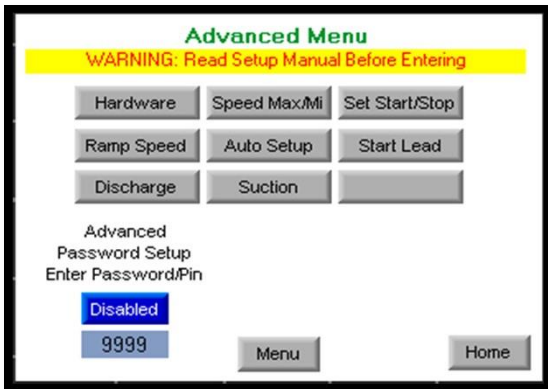

Advanced Menu may be Password Protected, refer to Password Entry Advanced screen.



If Password Protection for Advanced Menu is enabled, Password Entry Advanced screen will display when Advanced Menu button touched. When correct Password/Pin is entered Menu screen will display. If incorrect, returns to screen with message "Incorrect Password". Reenter correct Password/Pin or ESC.

See Password Disable/Enable Set Password/Pin Number screen.

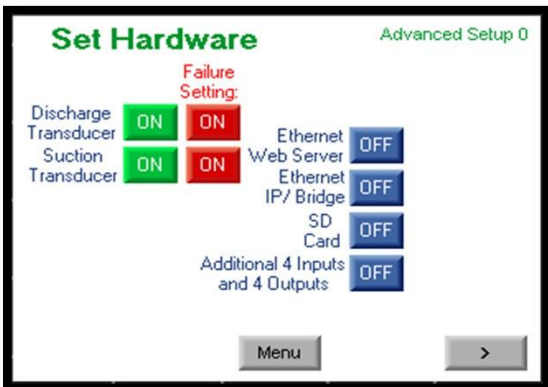

Select device that is currently connected to Controller. This is a Factory Setting and should never be adjusted without consulting factory.

BASIC DESCRIPTION AND OPERATION OF BOOSTER

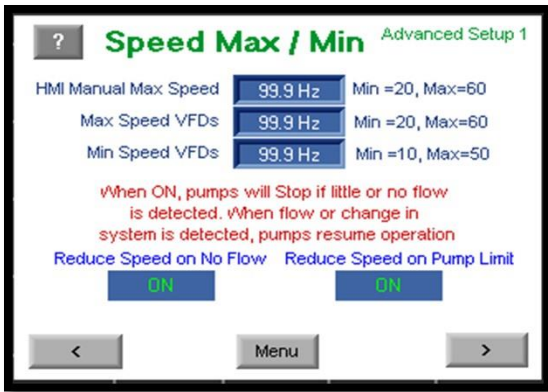

HMI Manual Max Speed (Hz) - Max speed (Hz) the VFD's can operate when set used as Manual Control operation via HMI.

Note - VFD keypad must be in Auto On for manual control through HMI.

Max and Min Speed VFDs - Maximum speed VFD can operate when in Auto On mode and Controller is in operation.

Reduce Speed on No Flow: If ON and no flow is detected, will stop pumps under normal operation.

Reduce Speed on Pump Limit: If ON and when pump is unable to reach pressure and in no flow, then set pressure will reduce until pressure is met and pumps turn Off.

? - Will take you to Information Screen.

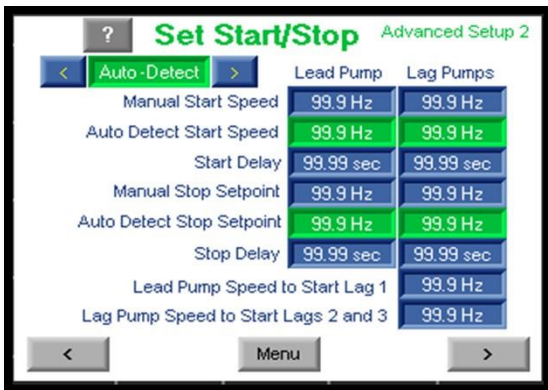

Auto Detect is factory default and preferred operation

Stop and Start Set points are set to minimum predicted speed when pump is no longer working efficiently.

Stop and Start Delay - Adjusted for system operation

Manual Start Speed, must be set before Manual Stop Set point.

Manual Stop Set point must be = < Manual Start Speed.

Speed to Start Lag must be set no > 59.5Hz Speed

Start Lag must be set = > Start Speed.

? - Will take you to Information Screen.

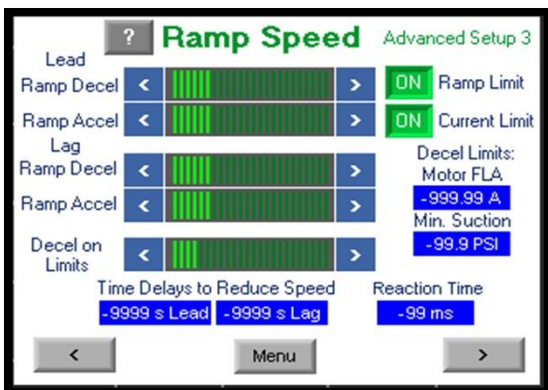

Ramp speeds set at Factory. Minimum adjustment for system operation may be necessary to fine tune system operation.

Ramp Limit ON- Lead and Lag Ramp Decel/Accel: Modifies ramp speed when sudden low or high demand occurs. Lead and Lag set to same level in normal operations.

Current Limit ON - Deceleration on Limits will be activated

when current or min suction has been exceeded. Once activated, it will reduce power to pump from Drive.

Motor FLA and Min. Suction for pump operation.

Time Delays to Reduce Speed: Delays Lead and Lag normal pump turn off sequence.

Reaction Time: PLC Real-time delay for operations.

Lead Pump Decel must be = > Lag Ramp Decel. Lead

Ramp Accel must be = > Lag Ramp Accel.

? - Will take you to Information Screen.

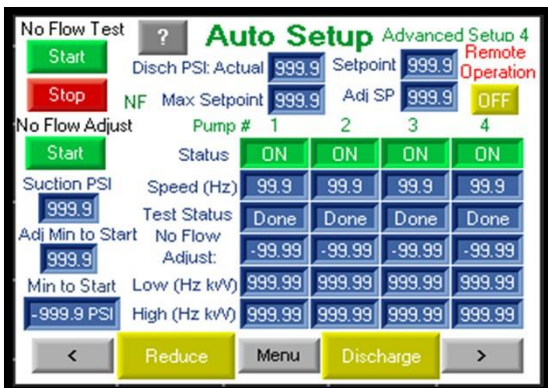

Current values will indicate settings as tested at Factory.

Setpoint = Discharge set point taken from Basic Screen 1.

Min to Start = Minimum Discharge Setpoint, Basic Screen 1.

Max Setpoint - Adjusts for Suction changes.

Adj SP - Adjusts for Suction changes.

Adj Min to Start - Adjusted for system variables running outside of normal conditions.

? - Will take you to Information Screen.

BASIC DESCRIPTION AND OPERATION OF BOOSTER

Auto-Commission- To commission your Intelliboost system you must have the Main Discharge Isolation Valve turned in the off position to ensure the booster is in a “no flow” condition. (Suction Main Isolation Valve remains open). No Flow Test or No Flow Adjust, required a means to ensure no flow can occur. Remote Operation, if available, must be Disabled. Booster pressure needs to be reduced during test, if necessary, through discharge pressure gauge valve.

Stop will cancel No Flow Test or No Flow Adjust Test at any time.

No Flow Adjust may be changed manually. NOTE: Before pressing Start, Zero out values present in No Flow Adjust columns.

No Flow Test:

VFDs for Pumps being tested must be in Auto. Press Start, changes to Running while testing, returns to Start upon completion. Reduce Discharge flashes when booster's pressure needs to be reduced, reduce until Reduce Discharge stops flashing. First Low and then High Hz kW Set-points will be determined for each drive in while testing is performed .

No Flow Adjust:

VFDs for Pumps being tested must be in Auto. Press Start, changes to Running while testing, returns to Start upon completion. Reduce Discharge will flash when booster's pressure needs to be reduced. Reduce pressure until Reduce Discharge stops flashing. No Flow Adjust will adjust until pump turns off.



Pressure Drop to Start Lead: If Discharge or Suction drop is > entered value and is < a sec. Lead Pump will start.

Suction Drop to Start Lead in No Flow - Updates system timers and set points.

Min. To Discharge to Start - Basic Setup 1.

Intervals to Start when No Flow - When system is inactive, a timed interval start will occur. Updates system timers and set points.

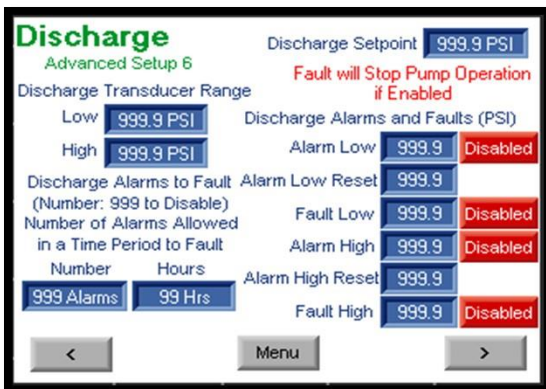

Discharge and Suction Transducers Range - Enter range marked on Transducer in PSI. Set at Factory.

Alarms to Fault – A number of Alarms activated per Alarm setting in assigned amount of hours will cause system to Fault and pumps will stop operating.

Alarms and Faults – Alarms are set values to warn of conditions that may be harmful or undesirable for system. Alarms Reset when system returns to desired operational values. Alarm is recorded in Number of Alarms. Faults are set values not to be exceeded. If exceeded, system will stop operating. Fault restart requires Operator assistance. Fault must be cleared or disabled for continued operation.

Alarm records can be retrieved in Fault and Alarm History.

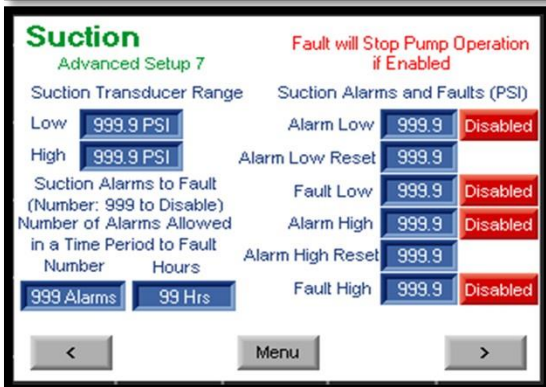

BASIC DESCRIPTION AND OPERATION OF BOOSTER



Bypass Password Protection. Basic and Advanced Passwords may be accessed from Home screen.

To Access:

Go to Home Screen

Touch the Time once (in right-hand upper corner)

Touch PENTAIR logo three times

Touch Discharge PSI text once

Controller:

Description: 16" h x 12" w x 8" d, NEMA 4 Enclosure (Optional NEMA 4X Clear Cover)

Power: 100-240 VAC 50/60 Hz

Operator Controls: Audible/Visual Alarm **Control Connections:**

RS485 Communication Port 1 to VFDs

RS485 Communication Port 2, See Modbus Slave Address Table Discharge Pressure Transducer (4-20 mA)

Suction Pressure Transducer (4-20 mA)

External Fault and Alarm inputs, (4) - User defined

Relay Outputs (6 amp, form 'C') fault and alarm, (4) - User defined

Additional I/O Connections:

External Fault and Alarm Inputs, maximum (8 total) – User defined Additional Relay Outputs (6 amp, form 'C'), maximum (8 total) - User defined **Additional Options:**

SD Card for application settings (Copy To and From SD Card) Ethernet, See Modbus Slave Address Table

Ethernet Webserver - Home Screen and Maintenance Alarm Screens

IntelliBoost System for PLC 570

Modbus Slave Address Table					
Booster Communication: Ethernet Modbus TCP IP Slave, Port 502					
Data: All packed values stored as most significant byte					
Host IP Address: _____, Subnet Mask: _____ Gateway: _____					
Connection: Port 3, RJ45					
Booster Communication: Serial Modbus RS 485 Slave, ID 1					
COM 2, 9600, 8, N, 1 (1/2 Duplex)					
Connection: Port 2, RJ12 on side of PLC Pin 1 (A+), Pin 6 (B-)					
Int #	Addr (Hex)	Function Description	16-bit	Read	Write
1	640	PLC Mode (Off/Auto) 0=Off, 1=Auto	X	X	
2	641	Alarm Active - 0=None, 1=Active	X	X	
3	642	Maintenance Alarm Active - 0=None, 1=Active	X	X	
4	643	Fault Active - 0=None, 1=Active	X	X	
5	644	Drive 1 Fault - 0=None, 1=Active	X	X	
6	645	Drive 2 Fault - 0=None, 1=Active	X	X	
7	646	Drive 3 Fault - 0=None, 1=Active	X	X	
8	647	Drive 4 Fault - 0=None, 1=Active	X	X	
9	648	Pump 1 Status (ON/OFF) 0=No Operation, 1=In Operation	X	X	
10	649	Pump 2 Status (ON/OFF) 0=No Operation, 1=In Operation	X	X	
11	64A	Pump 3 Status (ON/OFF) 0=No Operation, 1=In Operation	X	X	
12	64B	Pump 4 Status (ON/OFF) 0=No Operation, 1=In Operation	X	X	
13	64C	Pump 1 Comm Status (OK/Error) 0=OK, 1=Error - VFD to PLC	X	X	
14	64D	Pump 2 Comm Status (OK/Error) 0=OK, 1=Error - VFD to PLC	X	X	
15	64E	Pump 3 Comm Status (OK/Error) 0=OK, 1=Error - VFD to PLC	X	X	
16	64F	Pump 4 Comm Status (OK/Error) 0=OK, 1=Error - VFD to PLC	X	X	
17	650	All Status Bits (1-16), Most significant byte first	X	X	
18	651	VFD 1 Mode - 0=Auto, 1=Local, 2=HMI Manual, 3=Transducer Failure	X	X	
19	652	VFD 2 Mode - 0=Auto, 1=Local, 2=HMI Manual, 3=Transducer Failure	X	X	
20	653	VFD 3 Mode - 0=Auto, 1=Local 2=HMI Manual, 3=Transducer Failure	X	X	
21	654	VFD 4 Mode - 0=Auto, 1=Local 2=HMI Manual, 3=Transducer Failure	X	X	
22	655	Discharge PSI (Set Point) – 4 Digits, 1 Dec (999.9 PSI)	X	X	
23	656	Discharge PSI (Scaled Transducer Value) – 4 Digits, 1 Dec (999.9 PSI)	X	X	
24	657	Flow GPM (Set Point) – 4 Digits (9999 GPM)	X	X	
25	658	Flow GPM (Scaled Transducer Value) – 4 Digits (9999 GPM)	X	X	
26	659	Suction PSI (Scaled Transducer Value) – 4 Digits, 1 Dec (999.9 PSI)	X	X	
27	65A	Drive 1 Speed (99.9 Hz)	X	X	
28	65B	Drive 2 Speed (99.9 Hz)	X	X	
29	65C	Drive 3 Speed (99.9 Hz)	X	X	
30	65D	Drive 4 Speed (99.9 Hz)	X	X	
27	65E	Drive 1 KW (99.99 KW)	X	X	
28	65F	Drive 2 KW (99.99 KW)	X	X	
29	660	Drive 3 KW (99.99 KW)	X	X	
30	661	Drive 4 KW (99.99 KW)	X	X	
31	662	Discharge PSI (Set Point) – 4 Digits, 1 Dec (999.9 PSI)	X	X	X
32	663	Flow GPM (Set Point) – 4 Digits (9999 GPM)	X	X	X
33	664	PLC Mode (Off/Auto) 0=Off, 1=Auto	X	X	X

Troubleshooting Guide

Field Wiring

All wiring connections and wiring sizes must meet National Electrical Code and local requirements.

Motor Protection

See the motor nameplate for electrical connection/wiring diagram. Aurora® pumps must be used with the proper size and type of motor starter to ensure protection against damage from low voltage, phase failure, current imbalances, and overloads. The overload should be sized to trip at the full-load current rating of the motor.

OPERATION

Priming

WARNING! Risk of explosion and scalding.

Do not run the pump with the discharge valve closed; the water in the pump may boil, causing risk of explosion and steam burns to anyone nearby.

WARNING! Risk of electric shock.

Can shock, burn or kill. Disconnect all power to the pump before servicing or working on the pump. Make sure that the power is locked out and that the pump cannot be accidentally started.

NOTICE: Under no circumstances should the pump be operated without flow through the pump. Never operate the pump dry.

Operation of closed system or open system with the liquid level above the pump priming plug.

1. Close the discharge isolating valve and loosen the needle valve located in the assembly in the pump head (figure below). Do not remove the needle valve.

NOTICE: On PVM(X)2/4 models, remove the couple guard for access to the vent plug.

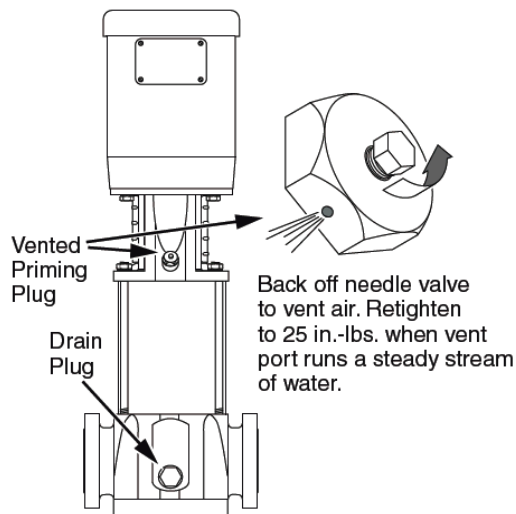

CAUTION! Risk of flooding.

Can cause personal injury and/or property damage. Watch the direction of the priming plug and make sure that the liquid escaping from it does not injure persons nearby or damage the motor or other components. In hot water installations, pay particular attention to the risk of injury from scalding hot water.

2. Slowly open the isolation valve in the suction pipe until a steady stream of liquid runs out the vent in the priming pot.
3. Tighten needle valve to 25 inch-pounds. Completely open isolation valves.

NOTICE: Please see to “Starting” before proceeding any further. Operation of open systems with the liquid level below the top of the pump:

NOTICE: The suction pipe requires a check valve or isolation valve.

1. Close to discharge isolation valve.
2. Remove the vented priming plug.
3. Pour liquid through the priming port until the suction pipe and the pump are completely filled with liquid.
4. Replace the vented priming plug and tighten it securely.
5. Repeat steps 1 - 4 until the pump is primed.

NOTICE: Please see “Starting” before proceeding any further.

CHECKING DIRECTION OF ROTATION

NOTICE: Do not disconnect the motor from the shaft to check the direction of rotation. If you remove the coupling, then you must adjust the shaft position when you reinstall it. This must be done before starting the pump.

Arrows on the pump head show the correct direction of rotation. When seen from the motor fan, the pump should rotate counterclockwise (↺). For pump motors without a fan, remove one of the coupling guards and look at the coupling to determine the direction of rotation. Turn off the pump and replace coupling guard.

NOTICE: Do not check the directions of rotation until the pump has been filled with liquid. See “Priming” above.

1. Switch power off.
2. Remove the coupling guard and rotate the pump shaft to be certain it can turn freely. Replace the coupling guard.
3. Verify that the electrical connections are in accordance with the wiring diagram on the motor.
4. If the fan is visible, turn on and off to verify rotation.
5. To reverse the direction of rotation, first switch OFF the power supply.
6. On three phase motors, switch 2 of the 3 power leads on the load side of the starter. On single phase motors, see the connection diagram on the motor nameplate. Change the wiring as indicated.

WARNING! Risk of electric shock.

Can shock, burn or kill. Ground the pump motor correctly before connecting to power supply per article 250-80 of National Electric Code (NEC) in the U.S., or the Canadian Electrical Code (CEC), as applicable.

7. Switch the power supply and recheck the direction of motor rotation.

STARTING

1. If a suction line isolation valve has been installed, check to be sure that it is completely opened.
2. For initial starting, the isolation valve in the discharge pipe should be almost closed.
3. Start the pump.
4. When the piping system has been filled with liquid, slowly open the discharge isolation until it is completely open. Opening the valve too fast may result in water hammer in the discharge pipe. If the pump or system starts to rattle, the pump is cavitating; to avoid damage to the pump, reduce the flow through the discharge isolation valve until the rattling stops. If this does not give adequate flow for your installation, call your installer or system designer.
5. Record the voltage and amperage of the motor. Adjust the motor overloads if required
6. If pressure gauges have been installed, check and record operating pressures.
7. Check all controls for proper operation.

WARNING!

If motor is nameplated for hazardous locations, do not run motor without all of the grease or drain plugs installed.

Relubrication Time Interval
 (For motors with regreasing provisions)

Service Conditions	NEMA Frame Size					
	140-180		210-360		400-510	
	1800 RPM and less	Over 1800 RPM	1800 RPM and less	Over 1800 RPM	1800 RPM and less	Over 1800 RPM
Standard	3 years	6 months	2 years	6 months	1 year	3 months
Severe	1 year	3 months	1 year	3 months	6 months	1 month
Season	1. For Motors nameplated as "belted duty only", divide the above intervals by 3 2. Lubricate at the beginning of the season. Then follow service schedule above.					

WARNING! Risk of electrical shock and possible unexpected starts.

Disconnect all power to the pump before servicing or working on pump. Make sure that power is locked out and that pump cannot be accidentally started.

Problem	Cause
1. Motor does not run when started	A. Power failure
	B. Fuses blown
	C. Motor starter overload has tripped out
	D. Main contacts in motor starter are not making contact or the coil is faulty.
	F. Motor is defective
2. Motor starter overload trips out immediately when power supply is switched on	A. One fuse has blown
	B. Contacts in motor overload relay are faulty
	C. Cable connections are loose or faulty
	D. Motor winding is defective
	E. Pump is mechanically blocked
	F. Overload setting is too low
3. Motor starter overload trips out occasionally	A. Overload setting is too low
	B. Low voltage at peak times
4. Motor starter has not tripped out but the motor does not run	A. Power failure
	B. Fuses blown
	C. Main contacts in motor starter are not making contact or the coil faulty
	D. Control circuit fuses are defective
5. Pump capacity is not constant	A. Pump inlet pressure is too low
	B. Suction pipe/pump is blocked
	C. Pump is sucking air
6. Pump runs but gives no water.	A. Suction pipe/pump is blocked
	B. Foot or nonreturn valve is blocked in closed position
	C. Leakage in suction pipe
	D. Air in suction pipe or pump
	E. Motor rotates in the wrong direction
7. Pumps runs backward when switched off	A. Leakage in suction pipe
	B. Foot or nonreturn valve is defective
	C. Foot valve is blocked in open or partly open position
	D. Nonreturn valve leaks or is blocked in open or partly open position
	E. Discharge valve is defective
8. Leakage from shaft seal	A. Pump shaft position is incorrect
	B. Shaft seal is defective
9.Noise	A. Cavitation is occurring in the pump
	B. Pump does not rotate freely (that is, there is increased frictional resistance) because of incorrect shaft position

NOTICE: The suction pipe requires a check valve or isolation valve.

1. Close to discharge isolation valve.

NOTICE: Please see “Starting” before proceeding any further.

CHECKING DIRECTION OF ROTATION

NOTICE: Do not disconnect the motor from the shaft to check the direction of rotation. If you remove the coupling, then you must adjust the shaft position when you reinstall it. This must be done before starting the pump.

Danfoss Drive Preventive Maintenance Instruction

PM Checklist

- Vacuum dust and dirt from heat sink fins
- Clean or replace as conditions require intake air filters (125 Hp constant torque models, 150 Hp variable torque models and larger have filters located behind the intake louver panels)
- Check ventilation fans for proper operation and clean as needed.
- Confirm VFD’s ventilation clearances have not been obstructed
- Check electrical connections and re-torque as needed. If possible, perform an IR thermal scan of the VFD’s power input and power output.
- Check line voltage
- Check motor & output phase balance
- Inspect DC buss capacitors (older drives)
- Record the VFD’s parameter settings using MCT-10
- Confirm the VFD doors and covers are in place and properly closed

2. Clean the drive’s interior.

- a. Dirt coating drive circuit boards and other components can interfere with proper cooling and even provide a path for electricity to short out along unintended paths. This can cause erratic operation and possibly damage to drive components.
- b. Corroded electrical connections can cause excess heat build-up, short circuits, erratic drive operation, and even component damage.
- c. This should be done after the installation of the drives is complete and before power is applied to the drive. The main point here is to ensure that no metal filings or other installation-related dirt are inside the drive or its option enclosure.
- d. If the drive is installed in an area where a lot of construction work will be performed, it is best to keep the drive covered while it is not in operation. Of course, if it is being used, the drive must be uncovered so that cooling air can be freely supplied to it. After the construction is complete it will be important to clean the interior of the drive. Low pressure, clean, dry air or similar commercial products can be used to clean dirt off of circuit boards. While a vacuum cleaner can be used to collect falling dirt, it is important to ensure that circuit boards are not damaged by the use of a powerful vacuum cleaner on the boards. Inspect drive connectors for dirt or corrosion.
- e. In a normal environment, the drive’s interior should be inspected annually and cleaned, if necessary. In dirty environments, more frequent inspection is required. The level of dirt found inside the drive can be used to dictate the frequency of inspections and cleanings that is required.

3. Clean air filters (if any).

- a. Many VLT drives have no air filters. However, some sizes and enclosure styles do use air filters in conjunction with their fan cooling systems. For these drives it is important to periodically inspect and clean or replace the filter element.
- b. Because the loading of the air filters can vary dramatically from one installation to another, it is important to initially check the air filters frequently to establish the required inspection interval

4. Check the tightness of connections.

- a. Loose power connections can cause extra heating and/or arcing. The heating reduces efficiency and can actually melt down connectors. The arcing can cause intermittent currents and electrical noise. These can disrupt the operation of the drive.
- b. Loose or corroded ground connections can cause electrical noise problems. All of the VLT drives have some degree of electrical noise filtering. Some of this electrical noise is sunk to earth ground. Without a reliable ground connection the noise filters cannot operate as designed. In addition, a poor ground connection can become a safety issue.
- c. Loose control wires can cause intermittent operation of equipment. Loose or missing shielding for signal wires can cause erratic operation of the drive. In an extreme case this can even cause the drive to trip off.
- d. The preventive maintenance procedure would involve first turning off power to the drive and waiting until the DC bus capacitors have discharged to a safe level. Then all of the accessible connections should be inspected for corrosion and checked for tightness. It should not be necessary to disassemble the drive to perform this operation.
- e. This should be performed once the drive is installed and at least annually afterward. If the drive is subjected to vibration or wide temperature variations, it should be checked more frequently.

5. Check cooling fans.

- a. Cooling fans are used to remove heat from the drive. Proper operation of the cooling fans helps ensure long drive life by keeping the drive's components cool. The cooling system should be inspected at least annually, more frequently when the drive is exposed to extreme conditions.
- b. Inspect the heat sinks, air inlets, and air outlets to ensure that there is an open path for air flow.
- c. The cooling fans in many VLT drives will turn themselves off when the drive's temperature is low enough to not require forced ventilation. To check for proper fan operation if the fans are not running, remove power from the drive. When power is reapplied the fans should start and run for a few seconds.
- d. Listen for unusual noises from the fans when they are running.
- e. The VLT drives use a heat sink temperature sensor to help indicate if there is a problem with the cooling system. If the drive issues a HEAT SINK OVERTEMP. warning or alarm, check the cooling system carefully.

6. Check bus capacitors for voltage balance and/or physical damage.

- a. The large DC bus capacitors in the drives are subject to deterioration over an extended period of time. It generally takes a significant number of years before any problems occur, although high ambient temperatures and other factors can accelerate this process.
- b. Problems with the DC bus capacitors generally first show up as a large "AC ripple voltage" being superimposed on the DC bus. The VLT 6000 continually monitors for excessive DC bus ripple, so it will generally provide an early warning of bus capacitor problems. If the drive gives a MAINS PHASE LOSS warning or alarm and a check of the input AC power line shows it to be balanced under loaded conditions, the DC bus capacitors should be checked carefully.
- c. On drives with an input power line voltage of 380 V AC or larger, the DC bus capacitors are connected as two banks that are in series with each other. With power applied to the drive, the voltage across the positive half should be within 10% of the voltage across the negative half.
- d. With power removed from the drive, a physical inspection of the capacitors should not show any deformation of the cases of the capacitors or liquid leaking from them.
- e. Low voltage capacitor testers are of no use in checking DC bus capacitors. The main concern is to ensure that the capacitors don't have excessive leakage current when the DC bus voltage is applied to it. This cannot be tested at a low voltage.
- f. If one capacitor on the DC bus is found to be weak or damaged, it is important to replace the entire capacitor bank. A capacitor with an excessive amount of leakage current places excessive stress on other capacitors in the bank.
- g. If it is convenient to access the two halves of the DC bus capacitors, the inspection technique given in "c" and "d" can be performed annually. Otherwise, it is best to simply let the drive's internal monitoring circuitry described in "b" provide an indication of possible problems.

Danfoss Drive Preventive Maintenance Instruction

1. PM Checklist

**Check
box**

Preventative Maintenance Step

- Vacuum dust and dirt from heat sink fins
- Clean or replace as conditions require intake air filters (125 Hp constant torque models, 150 Hp variable torque models and larger have filters located behind the intake louver panels)
- Check ventilation fans for proper operation and clean as needed.
- Confirm VFD's ventilation clearances have not been obstructed
- Check electrical connections and re-torque as needed. If possible, perform an IR thermal scan of the VFD's power input and power output.
- Check line voltage
- Check motor & output phase balance
- Inspect DC buss capacitors (older drives)
- Record the VFD's parameter settings using MCT-10
- Confirm the VFD doors and covers are in place and properly closed

2. Clean the drive's interior.

- a. Dirt coating drive circuit boards and other components can interfere with proper cooling and even provide a path for electricity to short out along unintended paths. This can cause erratic operation and possibly damage to drive components.
- b. Corroded electrical connections can cause excess heat build-up, short circuits, erratic drive operation, and even component damage.
- c. This should be done after the installation of the drives is complete and before power is applied to the drive. The main point here is to ensure that no metal filings or other installation-related dirt are inside the drive or its option enclosure.
- d. If the drive is installed in an area where a lot of construction work will be performed, it is best to keep the drive covered while it is not in operation. Of course, if it is being used, the drive must be uncovered so that cooling air can be freely supplied to it. After the construction is complete it will be important to clean the interior of the drive. Low pressure, clean, dry air or similar commercial products can be used to clean dirt off of circuit boards. While a vacuum cleaner can be used to collect falling dirt, it is important to ensure that circuit boards are not damaged by the use of a powerful vacuum cleaner on the boards. Inspect drive connectors for dirt or corrosion.
- e. In a normal environment, the drive's interior should be inspected annually and cleaned, if necessary. In dirty environments, more frequent inspection is required. The level of dirt found inside the drive can be used to dictate the frequency of inspections and cleanings that is required.

3. Clean air filters (if any).

- a. Many VLT drives have no air filters. However, some sizes and enclosure styles do use air filters in conjunction with their fan cooling systems. For these drives it is important to periodically inspect and clean or replace the filter element.

- b. Because the loading of the air filters can vary dramatically from one installation to another, it is important to initially check the air filters frequently to establish the required inspection interval.
4. Check the tightness of connections.
- a. Loose power connections can cause extra heating and/or arcing. The heating reduces efficiency and can actually melt down connectors. The arcing can cause intermittent currents and electrical noise. These can disrupt the operation of the drive.
 - b. Loose or corroded ground connections can cause electrical noise problems. All of the VLT drives have some degree of electrical noise filtering. Some of this electrical noise is sunk to earth ground. Without a reliable ground connection the noise filters cannot operate as designed. In addition, a poor ground connection can become a safety issue.
 - c. Loose control wires can cause intermittent operation of equipment. Loose or missing shielding for signal wires can cause erratic operation of the drive. In an extreme case this can even cause the drive to trip off.
 - d. The preventive maintenance procedure would involve first turning off power to the drive and waiting until the DC bus capacitors have discharged to a safe level. Then all of the accessible connections should be inspected for corrosion and checked for tightness. It should not be necessary to disassemble the drive to perform this operation.
 - e. This should be performed once the drive is installed and at least annually afterward. If the drive is subjected to vibration or wide temperature variations, it should be checked more frequently.
5. Check cooling fans.
- a. Cooling fans are used to remove heat from the drive. Proper operation of the cooling fans helps ensure long drive life by keeping the drive's components cool. The cooling system should be inspected at least annually, more frequently when the drive is exposed to extreme conditions.
 - b. Inspect the heat sinks, air inlets, and air outlets to ensure that there is an open path for air flow.
 - c. The cooling fans in many VLT drives will turn themselves off when the drive's temperature is low enough to not require forced ventilation. To check for proper fan operation if the fans are not running, remove power from the drive. When power is reapplied the fans should start and run for a few seconds.
 - d. Listen for unusual noises from the fans when they are running.
 - e. The VLT drives use a heat sink temperature sensor to help indicate if there is a problem with the cooling system. If the drive issues a HEAT SINK OVERTEMP. warning or alarm, check the cooling system carefully.
6. Check bus capacitors for voltage balance and/or physical damage.
- a. The large DC bus capacitors in the drives are subject to deterioration over an extended period of time. It generally takes a significant number of years before any problems occur, although high ambient temperatures and other factors can accelerate this process.
 - b. Problems with the DC bus capacitors generally first show up as a large "AC ripple voltage" being superimposed on the DC bus. The VLT 6000 continually monitors for excessive DC bus ripple, so it will generally provide an early warning of bus capacitor problems. If the drive gives a MAINS PHASE LOSS warning or alarm and a check of the input AC power line shows it to be balanced under loaded conditions, the DC bus capacitors should be checked carefully.
 - c. On drives with an input power line voltage of 380 V AC or larger, the DC bus capacitors are connected as two banks that are in series with each other. With power applied to the drive, the voltage across the positive half should be within 10% of the voltage across the negative half.

- d. With power removed from the drive, a physical inspection of the capacitors should not show any deformation of the cases of the capacitors or liquid leaking from them.
- e. Low voltage capacitor testers are of no use in checking DC bus capacitors. The main concern is to ensure that the capacitors don't have excessive leakage current when the DC bus voltage is applied to it. This cannot be tested at a low voltage.
- f. If one capacitor on the DC bus is found to be weak or damaged, it is important to replace the entire capacitor bank. A capacitor with an excessive amount of leakage current places excessive stress on other capacitors in the bank.
- g. If it is convenient to access the two halves of the DC bus capacitors, the inspection technique given in "c" and "d" can be performed annually. Otherwise, it is best to simply let the drive's internal monitoring circuitry described in "b" provide an indication of possible problems.

July 1, 2002

Aurora Pump
800 Airport Road
North Aurora, IL 60542
Phone: 630-859-7000
Fax: 630-859-7034

APPLICATIONS ENGINEERING NEWSLETTER

Bearing Lubrication Instructions for 300 Series End Suction Frame Mounted Pumps

Grease lubrication is standard for the Aurora End Suction Frame Mounted Pumps. Regreaseable bearings will require lubrication replacement and this can be accomplished by using the lubrication fitting at each bearing. Lubricate the bearings at regular intervals using high quality grease. The initial bearing lubrication at Aurora uses Chevron SRI Grease NLGI 2 (polyurea thickener). We recommend this grease for follow-up relubrication. Most major brands of Grade No. 2 ball bearing grease are satisfactory for pump operation in both wet and dry applications. Be aware that mixing of different brands of grease should be avoided due to possible chemical reactions between the brands that could damage the bearings. A thorough flushing of the old grease with the new is highly recommended to minimize this potential incompatibility. Avoid grease of vegetable or animal base that can develop acids, as well as grease containing rosin, graphite, talc or other impurities. Under no circumstances should grease be reused.

In dry locations, each bearing will need lubrication at least every 4,000 hours of running time or every 6 to 12 months, whichever is more frequent. In wet locations the bearings should be lubricated at least after every 2,000 hours of running time or every 4 to 6 months, whichever is more frequent. A unit is considered to be installed in a wet location if the pump and motor are exposed to dripping water, to the weather, or to heavy condensation such as found in unheated and poorly ventilated underground locations.

To lubricate, inject grease into the lubrication fitting at the bearing cap near the coupling and also at the top of the bearing frame. Two to three shots of grease from a standard grease gun should be sufficient. The excess grease will drop into the frame.

Note: Aurora Pump Distribution Center stocks Chevron SRI #2 grease in 14 oz. tubes for grease guns under Aurora Part Number 384-0002-639.

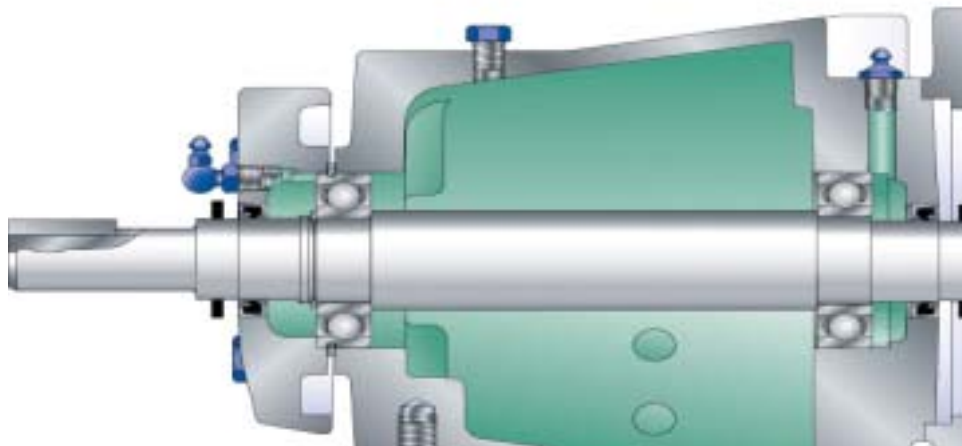

CAUTION

Overgreasing bearings can cause premature bearing and/or motor failure. The amount of grease added should be carefully controlled.

NOTE

If lubrication instructions are shown on the motor nameplate, they will supersede this general instruction.

Marathon Electric motors are pregreased with a polyurea mineral oil NGLI grade 2 type grease unless stated otherwise on the motor nameplate. Some compatible brands of polyurea mineral base type grease are: Chevron SRI #2, Rykon Premium #2, Exxon Polyrex EM or Texaco Polystar RB.

Motors are properly lubricated at the time of manufacture. It is not necessary to lubricate at the time of installation unless the motor has been in storage for a period of 12 months or longer (refer to lubrication procedure that follows).

LUBRICATION PROCEDURES

1. Stop motor. Disconnect and lock out of service.
2. Remove contaminants from grease inlet area.
3. Remove filler and drain plugs.
4. Check filler and drain holes for blockage and clean as necessary.
5. Add proper type and amount of grease. See the Relubrication Time Intervals table for service schedule and Relubrication Amounts table for volume of grease required.
6. Wipe off excess grease and replace filler and drain plugs (see following warning).
7. Motor is ready for operation.

WARNING

If motor is nameplated for hazardous locations, do not run motor without all of the grease or drain plugs installed.

RELUBRICATION TIME INTERVAL

(For motors with regreasing provisions).

Service Condition	NEMA FRAME SIZE					
	140-180		210-360		400-510	
	1800 RPM and less	Over 1800 RPM	1800 RPM and less	Over 1800 RPM	1800 RPM and less	Over 1800 RPM
Standard	3 yrs.	6 months	2 yrs.	6 months	1 yr.	3 months
Severe	1 yr.	3 months	1 yr.	3 months	6 months	1 month
Seasonal	See Note 2.					

NOTE

1. For motors nameplated as "belted duty only" divide the above intervals by 3.
2. Lubricate at the beginning of the season. Then follow service schedule above.

SEASONAL SERVICE: The motor remains idle for a period of 6 months or more.

STANDARD SERVICE: Up to 16 hours of operation per day, indoors, 100°F maximum ambient.

SEVERE SERVICE: Greater than 16 hours of operation per day. Continuous operation under high ambient temperatures (100° to 150°F) and/or any of the following: dirty, moist locations, high vibration (above NEMA standards), heavy shock loading, or where shaft extension end is hot.

RELUBRICATION AMOUNTS

(For motors with regreasing provisions).

NEMA FRAME SIZE	VOLUME cu. in. (fluid oz.)
140	.25 (.14)
180	.50 (.28)
210	.75 (.42)
250	1.00 (.55)
280	1.25 (.69)
320	1.50 (.83)
360	1.75 (.97)
400	2.25 (1.2)
440	2.75 (1.5)
500	3.00 (1.7)

TROUBLESHOOTING

WARNING

1. Disconnect power before working on motor or driven equipment.
2. Motors with automatic thermal protectors will automatically restart when the protector temperature drops sufficiently. Do not use motors with automatic thermal protectors in applications where automatic restart will be hazardous to personnel or equipment.
3. Motors with manual thermal protectors may start unexpectedly after protector trips. If manual protector trips, disconnect motor from power line. After protector cools (five minutes or more) it can be reset and power may be applied to motor.
4. Discharge all capacitors before servicing motor.
5. Always keep hands and clothing away from moving parts.
6. Never attempt to measure the temperature rise of a motor by touch. Temperature rise must be measured by thermometer, resistance, imbedded detector, or thermocouple.
7. Electrical repairs should be performed by trained and qualified personnel only.
8. Failure to follow instructions and safe electrical procedures could result in serious injury or death.
9. If safety guards are required, be sure the guards are in use.

If trouble is experienced in the operation of the motor, make sure that:

1. The bearings are in good condition and operating properly.
2. There is no mechanical obstruction to prevent rotation in the motor or in the driven load.
3. The air gap is uniform. (Consult manufacturer for specifications).
4. All bolts and nuts are tightened securely.
5. Proper connection to drive machine or load has been made.

In checking for electrical troubles, be sure that:

1. The line voltage and frequency correspond to the voltage and frequency stamped on the nameplate of the motor.
2. The voltage is actually available at motor terminals.
3. The fuses and other protective devices are in proper condition.
4. All connections and contacts are properly made in the circuits between the control apparatus and motor.

Field Wiring

All wiring connections and wiring sizes must meet National Electrical Code and local requirements.

Motor Protection

See the motor nameplate for electrical connection/wiring diagram.

Berkeley pumps must be used with the proper size and type of motor starter to ensure protection against damage from low voltage, phase failure, current imbalances, and overloads. The overload should be sized to trip at the full-load current rating of the motor.

OPERATION

Priming

▲ WARNING Risk of explosion and scalding. Do not run the pump with the discharge valve closed; the water in the pump may boil, causing risk of explosion and steam burns to anyone nearby.

▲ WARNING Risk of electric shock. Can shock, burn or kill. Disconnect all power to the pump before servicing or working on the pump. Make sure that the power is locked out and that the pump cannot be accidentally started.

NOTICE: Under no circumstances should the pump be operated without flow through the pump. Never operate the pump dry.

Operation of closed systems or open systems with the liquid level above the pump priming plug:

1. Close the discharge isolating valve and loosen the needle valve located in the assembly in the pump head (Figure 8). Do not remove the needle valve.

NOTICE: On BVMI(X)2/4 models, remove the coupling guard for access to the vent plug.

▲ CAUTION Risk of flooding. Can cause personal injury and/or property damage. Watch the direction of the priming plug and make sure that the liquid escaping from it does not injure persons nearby or damage the motor or other components. In hot water installations, pay particular attention to the risk of injury from scalding hot water.

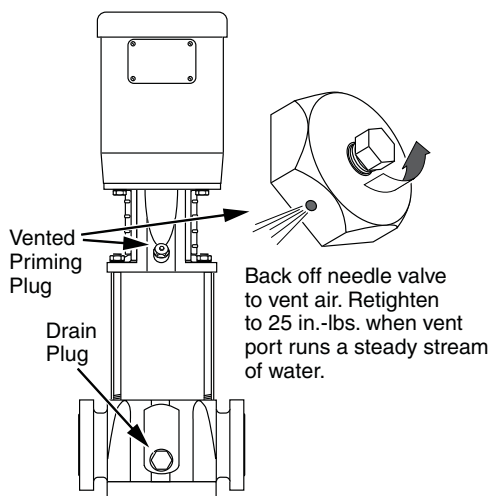

Figure 8 - Priming and Drain Plugs

2. Slowly open the isolation valve in the suction pipe until a steady stream of liquid runs out the vent in the priming port.
3. Tighten needle valve to 25 inch-pounds. Completely open isolation valves.

NOTICE: Please turn to *Starting* before proceeding any further.

Operation of open systems with the liquid level below the top of the pump:

NOTICE: The suction pipe requires a check valve or isolation valve.

1. Close the discharge isolation valve.
2. Remove the vented priming plug.
3. Pour liquid through the priming port until the suction pipe and the pump are completely filled with liquid.
4. Replace the vented priming plug and tighten it securely.
5. Repeat steps 1-4 until the pump is primed.

NOTICE: Please turn to *Starting* before proceeding any further.

Checking Direction of Rotation

NOTICE: Do not disconnect the motor from the shaft to check the direction of rotation. If you remove the coupling, then you must adjust the shaft position when you reinstall it. This must be done before starting the pump.

Arrows on the pump head show the correct direction of rotation. When seen from the motor fan, the pump should rotate counterclockwise (↺). For pump motors without a fan remove one of the coupling guards and look at the coupling to determine the direction of rotation. Turn off the pump and replace coupling guard.

NOTICE: Do not check the direction of rotation until the pump has been filled with liquid. See "Priming", at left and above.

1. Switch power off.
2. Remove the coupling guard and rotate the pump shaft to be certain it can turn freely. Replace the coupling guard.
3. Verify that the electrical connections are in accordance with the wiring diagram on the motor.
4. If the fan is visible, turn on and off to verify rotation.
5. To reverse the direction of rotation, first switch OFF the power supply.
6. On three-phase motors, switch 2 of the 3 power leads on the load side of the starter. On single-phase motors, see the connection diagram on the motor nameplate. Change the wiring as indicated.

▲ WARNING Risk of electric shock. Can shock, burn or kill. Ground the pump motor correctly before connecting to power supply per article 250-80 of National Electrical Code (NEC) in the U.S., or the Canadian Electrical Code (CEC), as applicable.

7. Switch on the power supply and recheck the direction of motor rotation.

Troubleshooting

▲WARNING Risk of electrical shock and possible unexpected starts. Disconnect all power to the pump before servicing or working on pump. Make sure that power is locked out and that pump cannot be accidentally started.

Problem	Cause
1. Motor does not run when started	A. Power failure
	B. Fuses blown
	C. Motor starter overload has tripped out
	D. Main contacts in motor starter are not making contact or the coil is faulty
	E. Control circuit fuses are defective
	F. Motor is defective
2. Motor starter overload trips out immediately when power supply is switched on	A. One fuse has blown
	B. Contacts in motor overload relay are faulty
	C. Cable connections are loose or faulty
	D. Motor winding is defective
	E. Pump mechanically blocked
	F. Overload setting is too low
3. Motor starter overload trips out occasionally	A. Overload setting is too low
	B. Low voltage at peak times
4. Motor starter has not tripped out but the motor does not run	A. Check 1 A), B), D,) and E)
5. Pump capacity is not constant	A. Pump inlet pressure is too low
	B. Suction pipe/pump partly blocked
	C. Pump is sucking air
6. Pump runs but gives no water	A. Suction pipe/pump blocked
	B. Foot or non-return valve is blocked in closed position
	C. Leakage in suction pipe
	D. Air in suction pipe or pump
	E. Motor rotates in the wrong direction
7. Pump runs backwards when switched off	A. Leakage in suction pipe
	B. Foot or non-return valve is defective
	C. Foot valve is blocked in open or partly open position
	D. Non return valve leaks or is blocked in open or partly open position
	E. Discharge valve is defective
8. Leakage from shaft seal	A. Pump shaft position is incorrect
	B. Shaft seal is defective
9. Noise	A. Cavitation is occurring in the pump
	B. Pump does not rotate freely (That is, there is increased frictional resistance) because of incorrect shaft position

G2 ELECTRICAL TERMINATIONS AND WIRING

DEUTSCH DT SERIES DT04-3P

Pin No.	Voltage Output	4-20mA Output*	Mating Cable Color
1 (B)	Common	V -	Black
2 (C)	Output	V -	White
3 (A)	V +	V +	Red

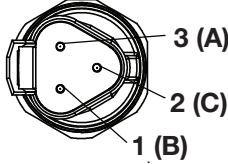

* Use either V- termination on G2 with 4-20mA output

DEUTSCH DTM SERIES DTM04-3P

Pin No.	Voltage Output	4-20mA Output*	Mating Cable Color
1	V +	V +	Red
2	Common	V -	Black
3	Output	V -	White

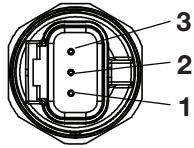

* Use either V- termination on G2 with 4-20mA output

SHIELDED CABLE, PVC JACKET, 24AWG LEADS

Wire Color	Voltage Output	4-20mA Output*
Red	V +	V +
Black	Common	V -
White	Output	V -
Bare**	Shield	Shield
	Drain Wire	Drain Wire

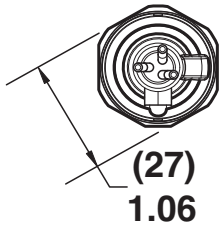

IP67 Ingress rating

* Use either V- termination on G2 with 4-20mA output

M12 ELECTRICAL TERMINATION FOR G2 (EW), (EO), (E2), (E1)

Mates to optional Hirschmann connector Part 933 172-100 or equal

Pin No.	Voltage Output	4-20mA Output*	Mating Cable Color
1	V +	V +	Red
2	Case Grd.	Case Grd.	Green
3	Common	V -	Black
4	Output	V -	White

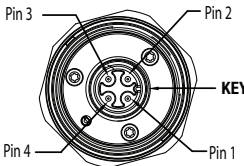

IP67 Ingress rating

G2 ELECTRICAL TERMINATIONS AND WIRING

FLYING LEADS 18AWG

Wire Color	Voltage Output	4-20mA Output*
Red	V +	V +
Black	Common	V -
White	Output	V -

IP67 Ingress rating

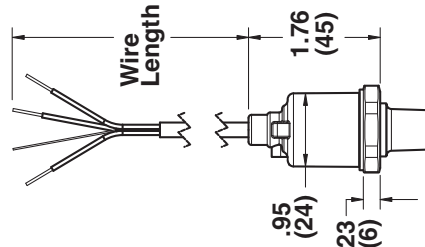

DIN 43650 FORM C (EN 175301-803-C) ELECTRICAL TERMINATION (DC), (N1), (N2), (N3), (N9)

Mates to Hirschmann P/N: GSSNR 300, Ashcroft P/N 300A126-01

Pin No.	Voltage Output	4-20mA Output*	Mating Cable Color
1	V +	V +	Red
2	Common	V -	Black
3	Output		White

IP65 Ingress rating

Connection - PIN

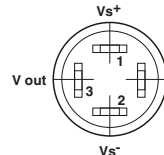

T2 ELECTRICAL TERMINATIONS AND WIRING

M12 ELECTRICAL TERMINATION FOR T2 (EW), (EO), (E2), (E1)

Mates to optional Hirschmann connector Part 933 172-100 or equal

Pin No.	Voltage Output	4-20mA Output*	Mating Cable Color
1	V +	V +	Red
2	Output	None	White
3	Case Grd.	Case Grd.	Green
4	Common	Common	Black

IP65 Ingress rating

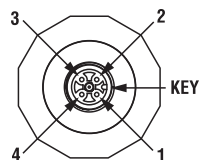

T2 ELECTRICAL TERMINATIONS AND WIRING

DIN 43650 FORM A (EN 175301-803-A) ELECTRICAL TERMINATION (DN), (DO), (D2), (D1)

Mates to optional Hirschmann connector GDM 3009 or equal

Pin No.	Voltage Output	4-20mA Output*	Mating Cable Color
1	V +	V +	Red
2	Common	Common	Black
3	Output	None	White
GND Case Gnd.		Case Gnd.	Green

IP65 Ingress rating

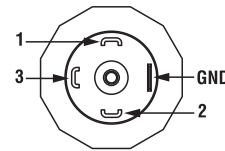

4-PIN BENDIX STYLE ELECTRICAL TERMINATION (B4), (H1), (L1), (P2)

Mates to optional Amphenol Bendix connector PT06A-8-4-SR or equal

Pin No.	Voltage Output	4-20mA Output*	Mating Cable Color
A	V +	V +	Red
B	Output	None	White
C	Case Gnd.	Case Gnd.	Green
D	Common	Common	Black

IP65 Ingress rating

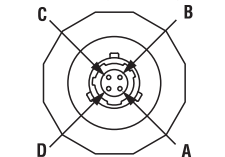

SHIELDED CABLE, PVC JACKET, 24 AWG LEADS, TERMINATION (F2), (P1)

Wire Color	Voltage Output	4-20mA Output
Red	V +	V +
White	Output	None
Black	Common	Common
Green	Case Gnd.	Case Gnd.
Bare**	Drain Wire	Drain Wire

IP65 Ingress rating

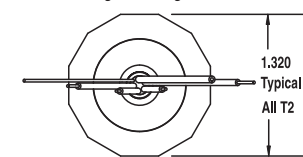

** Where shielded wiring is being used; Connect the drain wire to the guard terminal on the read out device or measuring instrument if available. In all other cases connect to the ground of the power supply negative terminal.

© 2011 Ashcroft Inc., 250 East Main Street, Stratford, CT 06614 USA, Tel: 203-378-8281, Fax 203-385-0402 www.ashcroft.com
All sales subject to standard terms and conditions of sale.
All rights reserved. I&M011-10129 03/2011 Rev. 10/2012, 07/13

ASHCROFT®

G2 & T2 PRESSURE TRANSMITTER

INSTRUCTION SHEET



WARNING! READ BEFORE INSTALLATION



1. GENERAL:

A failure resulting in **injury** or **damage** may be caused by excessive overpressure, excessive vibration or pressure pulsation, excessive instrument temperature, corrosion of the pressure containing parts, or other misuse. Consult Ashcroft Inc., Stratford, Connecticut, USA before installing if there are any questions or concerns.

2. OVERPRESSURE:

Pressure spikes in excess of the rated overpressure capability of the transducer may cause **irreversible electrical and/or mechanical damage** to the pressure measuring and containing elements.

Fluid hammer and surges can destroy any pressure transducer and must always be avoided. A pressure snubber should be installed to eliminate the damaging hammer effects. Fluid hammer occurs when a liquid flow is suddenly stopped, as with quick closing solenoid valves. Surges occur when flow is suddenly begun, as when a pump is turned on at full power or a valve is quickly opened.

Liquid surges are particularly damaging to pressure transducers if the pipe is originally empty. To avoid damaging surges, fluid lines should remain full (if possible), pumps should be brought up to power slowly, and valves opened slowly. To avoid damage from both fluid hammer and surges, a surge chamber should be installed.

Symptoms of fluid hammer and surge's damaging effects:

- Pressure transducer exhibits an output at zero pressure (large zero offset).
- Pressure transducer output remains constant regardless of pressure
- In severe cases, there will be no output.

FREEZING:

Prohibit freezing of media in pressure port. Unit should be drained (mount in vertical position with electrical termination upward) to prevent possible overpressure damage from frozen media.

* Use either V- termination on G2 with 4-20mA output

3. STATIC ELECTRICAL CHARGES:

Any electrical device may be susceptible to damage when exposed to static electrical charges. To avoid damage to the transducer observe the following:

- Ground the body of the transducer BEFORE making any electrical connections.

- When disconnecting, remove the ground LAST!

Note: The shield and drain wire in the cable (if supplied) is not connected to the transducer body, and is not a suitable ground.

DESCRIPTION

The Ashcroft Model G2 and T2 pressure transducers are high performance instruments intended for use in industrial applications where the process media is compatible with the 17-4PH stainless steel sensor material and the 304 SS process connection.

MECHANICAL INSTALLATION

Environmental

The G2 and T2 transducers can be stored and used within the temperature limits of -40°C to 125°C (-40°F to 257°F). Ingress protection ratings of the units are dependent on the electrical termination specified. Refer to the wiring diagrams on the reverse for the IP rating of the unit which is being installed.

Mounting

The G2 and T2 transducers require no special mounting hardware and can be mounted in any orientation with negligible position error. Although the units can withstand considerable vibration without damage or significant output effects, it is always good practice to mount the transducer where there is minimum vibration. For units with NPT type pressure fittings apply sealing tape or an equivalent sealant to the threads before installing. When installing or removing the unit apply a wrench to the hex wrench flats, located above the pressure fitting.

DO NOT tighten by using a pipe wrench on the housing. A 27mm (1 1/8") wrench can be used on the wrench flats of the hex. For G2 models with detachable electrical connectors a 6 point deep socket can also be used to install the unit.

Electro-Magnetic Interference

The circuitry of the G2 and T2 transducers is designed to minimize the effect of electromagnetic and radio frequency interference. To minimize susceptibility to noise, avoid running the termination wiring in a conduit which contains high current AC power cables. Where possible avoid running the termination wiring near inductive equipment.

Field Adjustments

The G2 and T2 transducers are precisely calibrated and temperature compensated at the factory to ensure long and stable performance. There are no field accessible adjustments on the G2 or T2 transducers.

ELECTRICAL INSTALLATION

Please refer to the reverse of this page for power supply requirements and for appropriate wiring protocol based on the particular output signal and electrical terminal.

G2 & T2 ELECTRICAL INSTALLATION

Wiring Diagrams (see following pages for further detail)

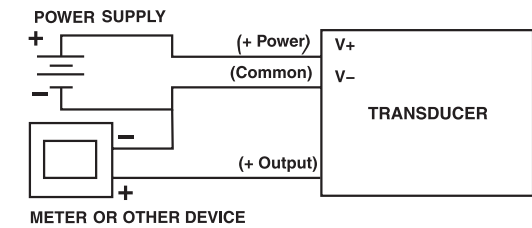
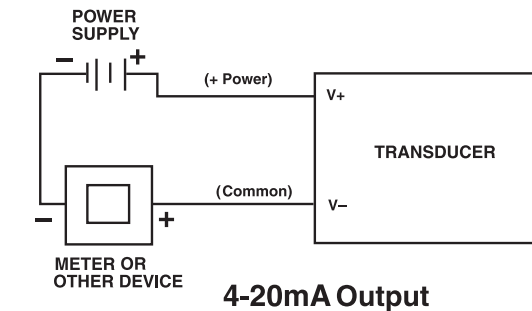

G2 & T2 ELECTRICAL INSTALLATION (cont.)

Power Supply Requirements:

Output Signal	Min Supply	Max Supply
Ratiometric* (0.5V to 4.5V)	4.5Vdc	5.5Vdc
0-5Vdc	9Vdc	36Vdc
1-5Vdc	9Vdc	36Vdc
1-6Vdc	9Vdc	36Vdc
0-10V	14Vdc	36Vdc
0.5-4.5Vdc	9Vdc	36Vdc
4-20mA**	9Vdc	36Vdc

*0.5Vdc-4.5Vdc output is ratiometric to the nominal 5Vdc supply

**For transmitters with 4-20mA output signal, the minimum voltage at the terminals is 9Vdc. However, the minimum supply voltage should be calculated using the adjacent graph and formula.

Power Supply Voltage vs Loop Resistance

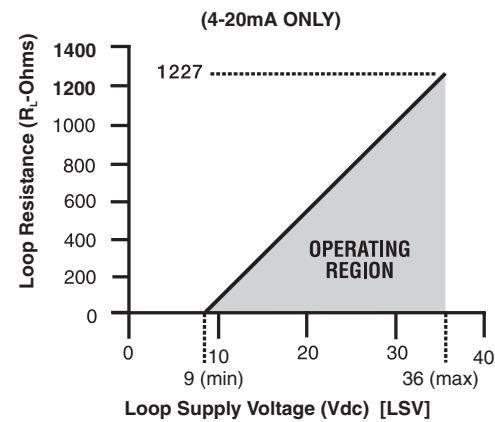

To determine minimum loop supply voltage:

$$LSV(\min) = 9(V) + [0.022(A) * R_L]$$

Where:

LSV = Loop Supply Voltage (Vdc)

$R_L = R_S + R_W$ (ohms)

R_L = Loop Resistance (ohms)

R_S = Sense Resistance (ohms) [Measuring Instrument]

R_W = Wiring Resistance (ohms)

G2 ELECTRICAL TERMINATIONS AND WIRING

3-PIN DELPHI (PACKARD) METRI-PACK 150 SERIES

Mates to Optional Metri-Pack connector 12065287

Pin No.	Voltage Output	4-20mA Output*	Mating Cable Color
A	Common	V-	Black
B	V+	V+	Red
C	Output	V-	White

IP67 Ingress rating

* Use either V- termination on G2 with 4-20mA output

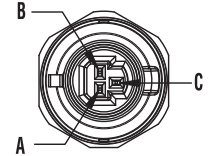

HIRSCHMANN G SERIES

Mates to Optional Hirschmann G4W1F connector, or equal

Pin No.	Voltage Output	4-20mA Output*	Mating Cable Color
1	V+	V+	Red
2	Common	V-	Black
3	Output	V-	White
4	Case Gnd.	Case Gnd.	Green

IP67 Ingress rating

* Use either V- termination on G2 with 4-20mA output

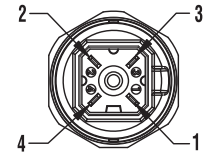

AMP SUPERSEAL

Pin No.	Voltage Output	4-20mA Output*	Mating Cable Color
1	Common	V-	Black
2	Output	V-	White
3	V+	V+	Red

* Use either V- termination on G2 with 4-20mA output

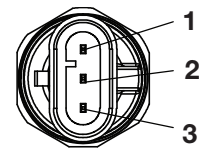

WARRANTY

Seller warrants equipment (and its component parts) of its own manufacture against defects in materials and workmanship under normal use and service for one (1) year from the date of installation or start-up, or for eighteen (18) months after the date of shipment, whichever occurs first. Seller does not warrant accessories or components that are not manufactured by Seller; however, to the extent possible, Seller agrees to assign to Buyer its rights under the original manufacturer's warranty, without recourse to Seller. Buyer must give Seller notice in writing of any alleged defect covered by this warranty (together with all identifying details, including the serial number, the type of equipment, and the date of purchase) within thirty (30) days of the discovery of such defect during the warranty period. No claim made more than 30 days after the expiration of the warranty period shall be valid. Guarantees of performance and warranties are based on the use of original equipment manufactured (OEM) replacement parts. Seller assumes no responsibility or liability if alterations, non-authorized design modifications and/or non-OEM replacement parts are incorporated. If requested by Seller, any equipment (or its component parts) must be promptly returned to Seller prior to any attempted repair, or sent to an authorized service station designated by Seller, and Buyer shall prepay all shipping expenses. Seller shall not be liable for any loss or damage to goods in transit, nor will any warranty claim be valid unless the returned goods are received intact and undamaged as a result of shipment. Repaired or replaced material returned to customer will be shipped F.O.B., Seller's factory. Seller will not give Buyer credit for parts or equipment returned to Seller, and will not accept delivery of any such parts or equipment, unless Buyer has obtained Seller's approval in writing. The warranty extends to repaired or replaced parts of Seller's manufacture for ninety (90) days or for the remainder of the original warranty period applicable to the equipment or parts being repaired or replaced, whichever is greater. This warranty applies to the repaired or replaced part and is not extended to the product or any other component of the product being repaired. Repair parts of its own manufacture sold after the original warranty period are warranted for a period of one (1) year from shipment against defects in materials and workmanship under normal use and service. This warranty applies to the replacement part only and is not extended to the product or any other component of the product being repaired. Seller may substitute new equipment or improve part(s) of any equipment judged defective without further liability. All repairs or services performed by Seller, which are not covered by this warranty, will be charged in accordance with Seller's standard prices then in effect.

THIS WARRANTY IS THE SOLE WARRANTY OF SELLER AND SELLER HEREBY EXPRESSLY DISCLAIMS AND BUYER WAIVES ALL OTHER WARRANTIES EXPRESSED, IMPLIED IN LAW OR IMPLIED IN FACT, INCLUDING ANY WARRANTIES OF MERCHANTABILITY OR FITNESS FOR A PARTICULAR PURPOSE. Seller's sole obligation under this warranty shall be, at its option, to repair or replace any equipment (or its component parts) which has a defect covered by this warranty, or to refund the purchase price of such equipment or part. Under the terms of this warranty, Seller shall not be liable for (a) consequential, collateral, special or liquidated losses or damages; (b) equipment conditions caused by normal wear and tear, abnormal conditions of use, accident, neglect, or misuse of said equipment; (c) the expense of, and loss or damage caused by, repairs or alterations made by anyone other than the Seller; (d) damage caused by abrasive materials, chemicals, scale deposits, corrosion, lightning, improper voltage, mishandling, or other similar conditions; (e) any loss, damage, or expense relating to or resulting from installation, removal or reinstallation of equipment; (f) any labor costs or charges incurred in repairing or replacing defective equipment or parts, including the cost of reinstalling parts that are repaired or replaced by Seller; (g) any expense of shipment of equipment or repaired or replacement parts; or (h) any other loss, damage or expense of any nature.

The above warranty shall not apply to any equipment which may be separately covered by any alternate or special warranties.

PERFORMANCE: In the absence of Certified Pump Performance Tests, equipment performance is not warranted or guaranteed. Performance curves and other information submitted to Buyer are approximate and no warranty or guarantee shall be deemed to arise as a result of such submittal. All testing shall be done in accordance with Seller's standard policy under Hydraulic Institute procedures.

LIABILITY LIMITATIONS: Under no circumstances shall the Seller have any liability under the Order or otherwise for liquidated damages or for collateral, consequential or special damages or for loss of profits, or for actual losses or for loss of production or progress of construction, regardless of the cause of such damages or losses. In any event, Seller's aggregate total liability under the Order or otherwise shall not exceed the contract price.

ACTS OF GOD: Seller shall in no event be liable for delays in delivery of the equipment or other failures to perform caused by fires, acts of God, strikes, labor difficulties, acts of governmental or military authorities, delays in transportation or procuring materials, or causes of any kind beyond Seller's control.

COMPLIANCE WITH LAW: Seller agrees to comply with all United States laws and regulations applicable to the manufacturing of the subject equipment. Such compliance shall include: The Fair Labor Standards Acts of 1938, as amended; Equal Employment Opportunity clauses of Executive Order 11246, as amended; Occupational Safety and Health Act of 1970 and the standards promulgated thereunder, if applicable. Since compliance with the various Federal, State, and Local laws and regulations concerning occupational health and safety, pollution or local codes are affected by the use, installation and operation of the equipment and other matters over which Seller has no control, Seller assumes no responsibility for compliance with those laws and regulations, whether by way of indemnity, warranty, or otherwise. It is incumbent upon the Buyer to specify equipment which complies with local codes and ordinances.



AURORA®

800 Airport Road
North Aurora, Illinois 60542
630-859-7000
www.aurorapump.com