



**FLECK** 5800 XTR2  
SERVICE MANUAL



# TABLE OF CONTENTS

JOB SPECIFICATION SHEET ..... 2

INSTALLATION ..... 3

START-UP INSTRUCTIONS/FLUSHING & CONDITIONING ..... 5

SYSTEM DISINFECTION ..... 5

TOUCHSCREEN CONTROL QUICK START ..... 6

TOUCHSCREEN CONTROL FEATURES ..... 8

MASTER SETTINGS PROGRAMMING ..... 12

MASTER RESET ..... 17

CONTROL OPERATION ..... 17

ALARMS AND ERRORS ..... 17

MASTER SETTINGS REFERENCE CHART ..... 18

TROUBLESHOOTING ..... 19

5800 XTR2 CONTROL VALVE ASSEMBLY ..... 20

5800 VALVE ACCESSORIES ..... 22

5800 VALVE ASSEMBLIES ..... 23

TURBINE METER ASSEMBLY - P/N 60626 ..... 24

PADDLE METER ASSEMBLY -P/N 60086-50 ..... 24

BYPASS VALVE ASSEMBLY (METAL) ..... 25

BYPASS VALVE ASSEMBLY (PLASTIC) ..... 25

SAFETY BRINE VALVE ..... 26

WATER CONDITIONER FLOW DIAGRAMS ..... 27

DIMENSIONAL DRAWINGS ..... 29

TRANSFORMER PORT LOCATION ..... 30

INJECTOR FLOW DATA ..... 31

WIRING DIAGRAM ..... 32

# JOB SPECIFICATION SHEET

Job Number: \_\_\_\_\_

Model Number: \_\_\_\_\_

Water Hardness: \_\_\_\_\_ ppm or gpg

Capacity Per Unit: \_\_\_\_\_

Mineral Tank Size: \_\_\_\_\_ Diameter: \_\_\_\_\_ Height: \_\_\_\_\_

Salt Setting per Regeneration: \_\_\_\_\_

Regenerant Flow: Downflow Upflow Backwash Downflow 2x Backwash  
Filter Upflow Variable Refill Custom Downflow Custom Upflow

**1. Meter Size:**

- A. 3/4" Paddle Wheel Turbine
- B. 1" Paddle Wheel Turbine
- C. 1-1/2" Paddle Wheel Turbine
- D. 2" Paddle Wheel
- E. 3" Paddle Wheel
- F. Generic \_\_\_\_\_ Pulse Count \_\_\_\_\_ Meter Size \_\_\_\_\_

**2. System Type:**

- A. System #4: 1 Tank, 1 Meter, Immediate, or Delayed Regeneration
- B. System #4: Time Clock

**3. Cycle Settings:**

- A. Backwash: \_\_\_\_\_ Minutes
- B. Brine and Slow Rinse: \_\_\_\_\_ Minutes
- C. Rapid Rinse: \_\_\_\_\_ Minutes
- D. Brine Tank Refill: \_\_\_\_\_ Minutes
- E. Pause Time: \_\_\_\_\_ Minutes
- F. Second Backwash: \_\_\_\_\_ Minutes

**4. Drain Line Flow Control:** \_\_\_\_\_ gpm

**5. Brine Line Flow Control:** \_\_\_\_\_ gpm

**6. Injector Size#:** \_\_\_\_\_

**7. Battery Install/Change Date:** \_\_\_\_\_



**IMPORTANT PLEASE READ:**

- The information, specifications and illustrations in this manual are based on the latest information available at the time of release. The manufacturer reserves the right to make changes at any time without notice.
- This manual is intended as a guide for service of the valve only. System installation requires information from a number of suppliers not known at the time of manufacture. This product should be installed by a plumbing professional.
- This unit is designed to be installed on potable water systems only.
- This product must be installed in compliance with all state and municipal plumbing and electrical codes. Permits may be required at the time of installation.
- It is established that when daytime water pressure exceeds 80 psi (5.5 bar), the maximum pressure rating of 125 psi (8.6 bar) can be exceeded. A pressure regulator must be installed on this system or warranty is voided.
- Do not install the unit where temperatures may drop below 32°F (0°C) or above 120°F (52°C).
- Do not place the unit in direct sunlight. Black units will absorb radiant heat increasing internal temperatures.
- Warranty of this product extends to manufacturing defects. Misapplication of this product may result in failure to properly condition water, or damage to product.
- A prefilter should be used on installations in which free solids are present.
- In some applications local municipalities treat water with Chloramines. High Chloramine levels may damage valve components.
- Correct and constant voltage must be supplied to the controller to maintain proper function.

## CALIFORNIA PROPOSITION 65 WARNING

**⚠ WARNING:** This product contains chemicals known to the State of California to cause cancer or birth defects or other reproductive harm.

## INSTALLATION

### Water Pressure

A minimum of 20 psi (1.4 bar) of water pressure is required for the regeneration valve to operate effectively.

### Electrical Facilities

An uninterrupted alternating current (120 VAC) supply is required. The control uses a transformer to supply 12 VDC. Please make sure your voltage supply is compatible with your unit before installation.

### Existing Plumbing

Condition of existing plumbing should be free from lime and iron buildup. Piping that is built up heavily with lime and/or iron should be replaced. If piping is clogged with iron, a separate iron filter unit should be installed ahead of the water softener.

### Location of Softener and Drain

You must have an air gap on the drain line to prevent back flow of drain water into the system. A 2x the drain line pipe diameter air gap is required with a minimum 1" air gap.

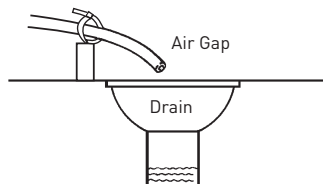

Figure 1

### Outdoor Locations

When the water conditioning system is installed outdoors, several items must be considered.

- Moisture — The system is not designed to withstand extreme humidity or water spray from below. Examples are: constant heavy mist, near corrosive environment, upwards spray from sprinkler.

**CAUTION** This unit is for dry location use only unless used with a Listed Class 2 power supply suitable for outdoor use.

- Direct Sunlight — The materials used will fade or discolor over time in direct sunlight. The integrity of the materials will not degrade to cause system failures. If it is necessary to locate the system in direct sunlight, a protective outdoor cover (P/N 61882) over the valve and controller is necessary.
- Insects — If installing in an environment that may expose the system to insects or other small animals, a protective cover is required. The protective outdoor cover (P/N 61882) has been designed to keep all but the smallest insects out of the critical areas. The cover should be installed securely in place.

### Bypass Valves

Always provide for the installation of a bypass valve if unit is not equipped with one.

**CAUTION** Water pressure is not to exceed 125 psi (8.6 bar), water temperature is not to exceed 110°F (43°C), and the unit cannot be subjected to freezing conditions.

**WARNING:** The system must be depressurized before removing any connections for servicing.

### Installation Instructions

1. Place the softener tank where you want to install the unit. Make sure the unit is level and on a firm base.

2. During cold weather, the installer should warm the valve to room temperature before operating.
3. All plumbing should be done in accordance with local plumbing codes. The pipe size for a residential drain line should be a minimum of 1/2" (13 mm). Backwash flow rates in excess of 7 gpm (26.5 Lpm) or drain line length in excess of 20' (6 m) require 3/4" (19 mm) drain line. Commercial drain lines should be the same size as the drain line flow control.

**NOTE:** The tank should have the distributor tube installed and have the proper amount of regenerant in place.

4. Refer to the dimensional drawing for cutting height of the distributor tube. If there is no dimensional drawing, cut the distributor tube flush with the top of the tank.
5. Lubricate the distributor O-ring seal and tank O-ring seal. Place the main control valve on tank. Note: Only use silicone lubricant.
6. Soldering of joints near the drain port must be done prior to connecting the Drain Line Flow Control fitting (DLFC). Leave at least 6" (15 cm) between the DLFC and solder joints when soldering pipes that are connected on the DLFC. Failure to do this could cause interior damage to the DLFC.
7. PTFE plumbing tape is the only sealant to be used on the drain fitting.
8. Make sure that the floor is clean beneath the salt storage tank and that the tank is level.
9. Place approximately 1" (25 mm) of water above the grid plate. If a grid is not utilized, fill to the top of the air check (Figure 2) in the salt tank. Do not add salt to the brine tank at this time.

**CAUTION** If grid plate is used, cut air check height even with grid plate. This is critical on 6", 7", 8" and 9" tanks. The brine refill water must come above the grid plate and make contact with the salt.

10. On units with a bypass, place in bypass position. Turn on the main water supply. Open a cold soft water tap nearby and let run a few minutes or until the plumbing is free from foreign material (usually solder) that may have resulted from the installation. Once clean, close the water tap.
11. Slowly place the bypass in service position and let water flow into the mineral tank. When water flow stops, slowly open a cold water tap nearby and let water run until the air is purged from the unit.
12. Plug the transformer into an electrical outlet.

**NOTE:** All electrical connections must be connected according to local codes. Be certain the outlet is uninterrupted.



Figure 2 Residential Air Check Valve

### Electrical Connection

The controller operates on 12-volt DC power supply. This requires use of the supplied power adapter included with your system. For installation assistance, see Transformer Port Location on page 30.

**NOTE:** The power source should be constant. Be certain the AC adapter is not on a switched outlet. Power interruptions longer than 8 hours may cause the controller to lose the time setting. When power is restored, the time setting must then be re-entered.

**Typical Residential System Plumbing**

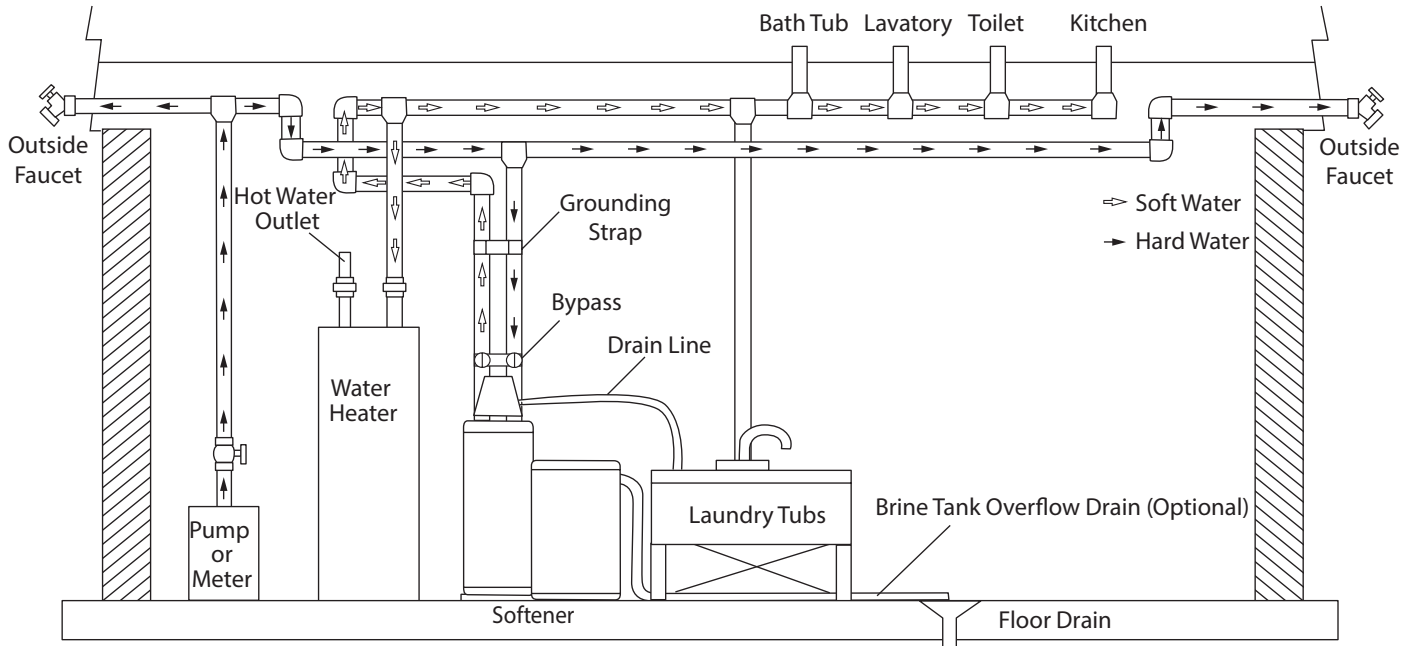

Figure 3 Softened Water Flow

## START-UP INSTRUCTIONS/ FLUSHING & CONDITIONING

---

The water softener should be installed with the inlet, outlet, and drain connections made in accordance with the manufacturer's recommendations, and to meet applicable plumbing codes.

1. Program the valve control according to instructions shown in this manual.
2. Start an immediate regeneration by holding the Extra Cycle button for five seconds. Position the valve to backwash. Ensure the drain line flow remains steady for 10 minutes or until the water runs clear.
3. Position the valve to the brine draw/slow rinse position. Ensure the unit is drawing water from the brine tank (this step may need to be repeated).
4. Position the valve to the rapid rinse position. Check the drain line flow, and run for five minutes or until the water runs clear.
5. Position the valve to the start of the brine tank fill cycle. Ensure water goes into the brine tank at the desired rate. The brine valve drive cam will hold the valve in this position to fill the brine tank for the first regeneration.
6. Replace control cover.
7. Put salt in the brine tank.

**NOTE: Do not use granulated or rock salt.**

## SYSTEM DISINFECTION

---

### Disinfection of Water Softeners

The materials of construction of the modern water softener will not support bacterial growth, nor will these materials contaminate a water supply. During normal use, a softener may become fouled with organic matter, or in some cases with bacteria from the water supply. This may result in an off-taste or odor in the water.

Some softeners may need to be disinfected after installation and some softeners will require periodic disinfection during their normal life.

Depending upon the conditions of use, the style of softener, the type of ion exchanger, and the disinfectant available, a choice can be made among the following methods.

### Sodium or Calcium Hypochlorite

#### Application

These materials are satisfactory for use with polystyrene resins, synthetic gel zeolite, greensand and bentonites.

#### 5.25% Sodium Hypochlorite

These solutions are available under brand names of household bleach. If stronger solutions are used, such as those sold for commercial laundries, adjust the dosage accordingly.

1. Dosage
  - A. Polystyrene resin; 1.2 fluid ounce (35.5 ml) per cubic foot.
  - B. Non-resinous exchangers; 0.8 fluid ounce (23.7 ml) per cubic foot.
2. Salt tank softeners
  - A. Backwash the softener and add the required amount of hypochlorite solution to the well of the salt tank. The salt tank should have water in it to permit the solution to be carried into the softener.
  - B. Proceed with the normal recharge.

#### Calcium Hypochlorite

Calcium hypochlorite, 70% available chlorine, is available in several forms including tablets and granules. These solid materials may be used directly without dissolving before use.

1. Dosage
  - A. Two grains (approximately 0.1 ounce [3 ml]) per cubic foot.
2. Salt tank softeners
  - A. Backwash the softener and add the required amount of hypochlorite to the well of the salt tank. The salt tank should have water in it to permit the chlorine solution to be carried into the softener.
  - B. Proceed with the normal recharge.

## TOUCHSCREEN CONTROL QUICK START

The XTR2 control was designed to be easy to set up and begin using right out of the box. The following simple procedure can be used to set up the system and begin treating water in most typical applications.

**NOTE: Steps 2 and 3 are optional and are not required to start the system. All control settings may be changed after the unit is in service.**

**NOTE: Press  on any Quick Start screen to reset the screen back to its default settings.**

1. After plugging in the unit, the Format screen (Figure 4) is displayed.

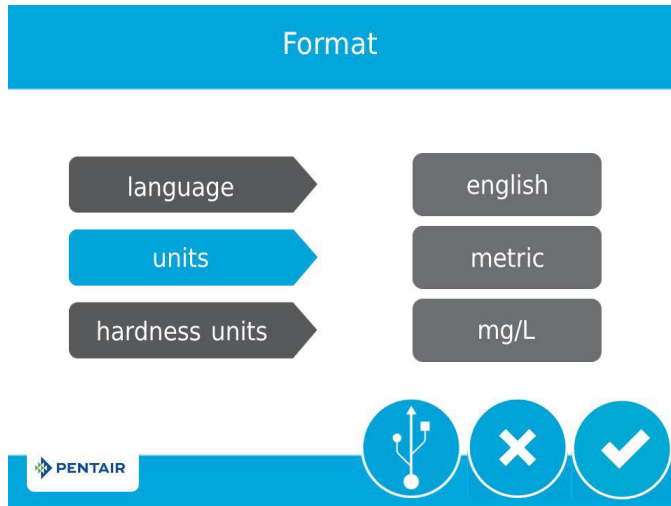





Figure 4 Format Screen

Press the **language** button to adjust the system's displayed language (international version only): English, French, German, Italian, Spanish, or Dutch. Press  when finished.

Press the **units** button to adjust the system's units of measure (either U.S. or metric). Press  when finished.

Press the **hardness units** button to adjust the system's hardness units of measure (grains per gallon, mg/L or ppm, German degrees, French degrees, or English degrees). Press  when finished. Hardness units are adjustable only if metric units are selected.

**NOTE: If the screen is blank after plugging in the unit, touch the screen to turn the screen on.**

2. After pressing , the Assistance/Mainten. Name screen (Figure 5) is displayed.



Figure 5 Assistance/Mainten. Name Screen

Using the keypad, type the name of the water treatment professional or company that the homeowner may call for system service (optional).

To enter a letter using the keypad, quickly press the keypad button the number of times that correspond with the position of the correct letter on the button. For example, to enter the letter "C", quickly press the ABC button three times. Press  when finished.

3. After pressing , the Assistance/Mainten. Phone screen (Figure 6) is displayed.

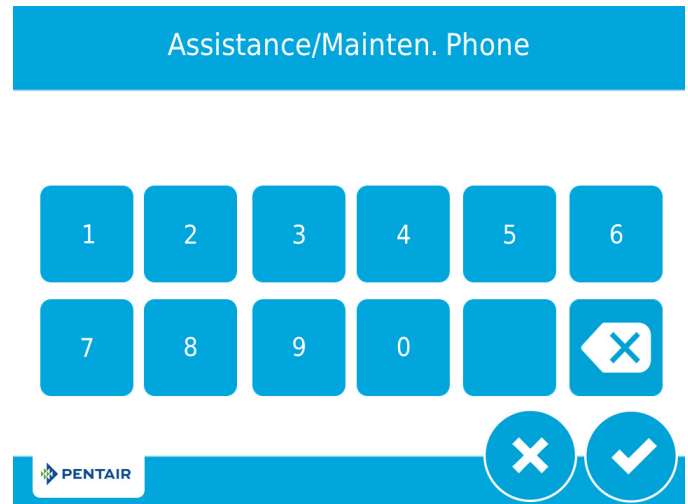



Figure 6 Assistance/Mainten. Phone Screen

Enter the phone number of the water treatment professional or company that the homeowner may call for system service (optional). Press  when finished.

4. After pressing , the Assistance/Mainten. Interval screen (Figure 7) is displayed.

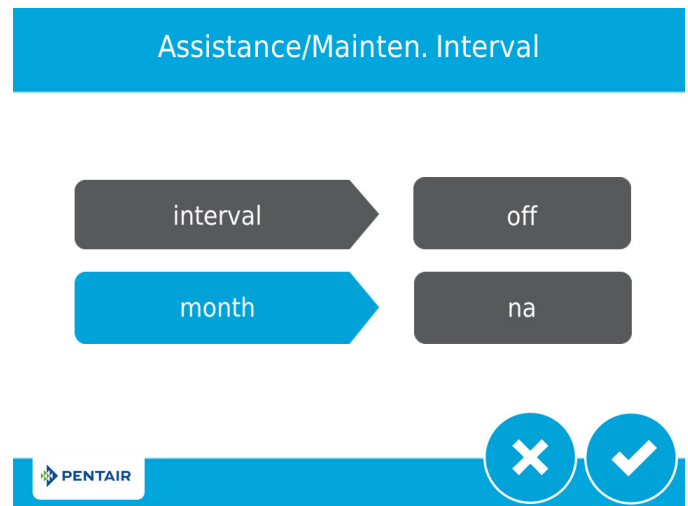



Figure 7 Assistance/Mainten. Interval Screen

Use the Assistance/Mainten. Interval screen to set the interval in which the homeowner will need to call a water treatment professional for system service (optional). The assistance interval can be based on a set number of months (month based) or a number of regenerations (regen based).

Press the **interval** button to select a month-based or regen-based assistance interval, then press . Press either the **month** or **regen** button (depending on your previous selection), and select the number of months (up to 60) or regenerations (up to 2000) until the homeowner will need to call for service. Press  when finished.

# TOUCHSCREEN CONTROL QUICK START

*continued*

5. After pressing , the Home screen (Figure 8) appears.

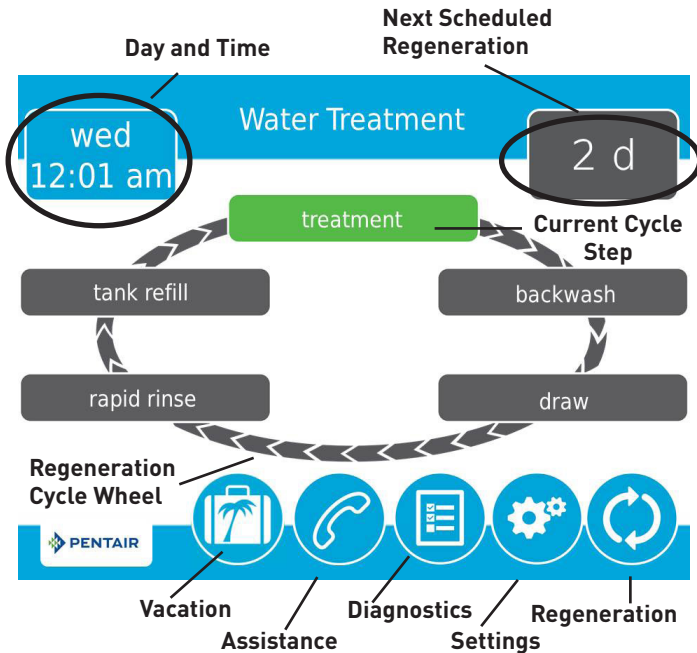

Figure 8 Home Screen

The **Day and Time** button will be flashing, indicating that the day of the week and time need to be set. If the date and time are incorrect, press the **Day and Time** button to update to the correct day and time. The Day and Time screen (Figure 9) appears.

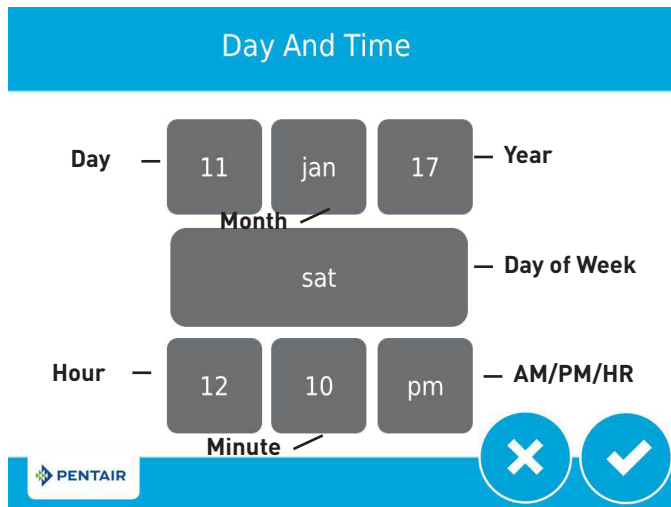





Figure 9 Day and Time Screen

Press the **Day of Week**, **Hour**, **Minute**, and **AM/PM/HR** buttons to adjust the values to the correct day of week and time. Setting the value of the **AM/PM/HR** button to HR changes the display to a 24 hour clock. Press the **Day**, **Month**, and **Year** buttons to adjust the values to the correct date. Press the  button when finished to return to the Home screen. Press  to return to the Home screen without saving.

6. Start a regeneration by pressing the **Regeneration** button . The Regeneration screen appears (Figure 10).

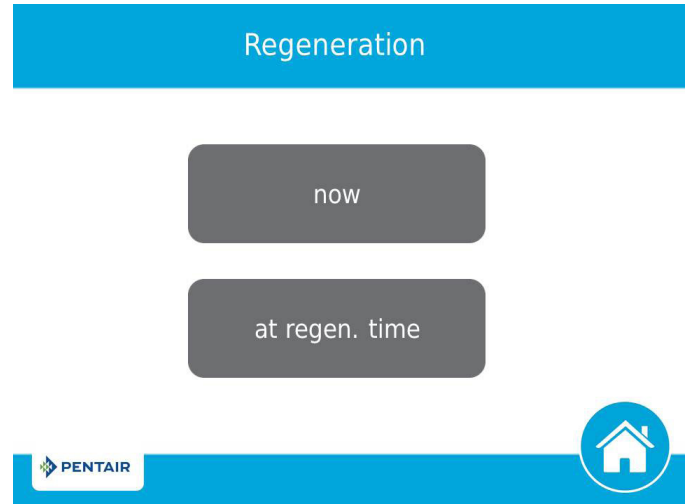



Figure 10 Regeneration Screen

- Press **now** to begin a regeneration immediately, or press **at regen. time** to queue the regeneration for the programmed regeneration time (2:00 AM default for softeners, 12:00 AM default for filters). Pressing **at regen. time** again will cancel the manual regeneration.
- During Regeneration, press the  button to immediately advance to the next cycle step. Once in regeneration, the volume or time will be displayed below the  button.

7. For softener systems, put salt in the brine tank.

**NOTE: Do not use granulated or rock salt.**

The unit is now fully programmed and ready to treat water. This quick setup uses the control's default settings, which are appropriate for most residential applications.

## TOUCHSCREEN CONTROL FEATURES

### Features of the XTR2 Touchscreen Control

- Full-featured easy to use graphical touchscreen interface for programming, servicing, and diagnostics.
- Non-linear programming no longer requires cycling through every parameter when programming/servicing.

### Buttons and Symbols

**NOTE: Not all buttons appear on all screens.**

#### Regeneration Cycle Wheel

- Displays the regeneration cycle step the system is currently in. The wheel rotates with each step so that the current step is shown in green.

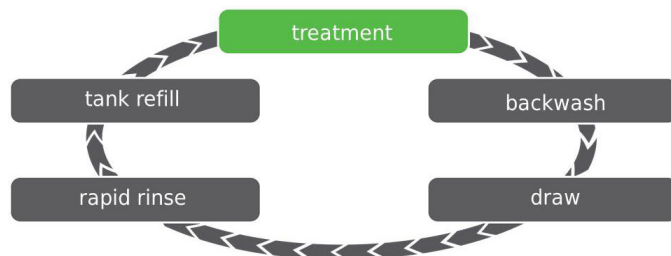

**NOTE: On metered units, the "Treatment" step on the Regeneration Cycle Wheel will flash when water is flowing through the unit.**

#### Home



- Displays the Home screen.

#### Regeneration



- Displays the Regeneration screen, which allows you to start a regeneration and manually cycle through the regeneration steps.

#### Settings



- Displays the Settings screen, which allows you to adjust commonly used settings. Pressing this button while in the Settings screen provides access to the Master Settings screen, which allows you to fully program the valve.

**NOTE: Due to the complexity of these settings and the potential for errors, Master Settings should only be accessed by your local water professional.**

#### Diagnostics



- Displays the Diagnostic screen, which can assist in performing maintenance and troubleshooting performance issues with the valve.

#### Brightness/Sound



- Displays the Brightness/Sound screen, which allows you to adjust the backlight of the control screen and allows you to mute the alarms of the control.

#### Vacation Mode



- Halts all scheduled regenerations when pressed; press again to resume normal operation. When Vacation Mode is on, the 100 day regeneration error will be suspended.

#### Assistance



- Displays a name and phone number to call for unit service.

#### USB Connect



- Allows you to connect the control to a PC via a USB cable for field programming or download of diagnostic parameters via PC (Field Programmer application required).

#### Screen Navigation Arrows



- Displayed in the upper-left and upper-right corners of the screen, these arrows allow you to navigate from one screen to another. **NOTE: Settings on previous screen are not saved unless  is pressed.**

#### Settings Arrows



- These arrows allow you to change the values of certain settings when programming the control.

#### Alarm



- Displayed when an alarm has been triggered; accompanied by an audible alarm. Press to silence the audible alarm.

#### Error



- Displayed when an error has occurred. Press to display the Error screen for more detailed error information.

#### Advance



- This arrow allows you to advance through cycle steps during a regeneration.

#### Reset



- Displayed in the Diagnostics screen to reset Totalizer and Peak Flow data and in Master Settings to reset parameters to factory or non-factory settings.

#### Accept



- Press to save or accept changes in control configuration.

#### Cancel



- Press to cancel configuration and exit to previous screen without saving.



# TOUCHSCREEN CONTROL FEATURES

*continued*

## Screen Features

### Home Screen

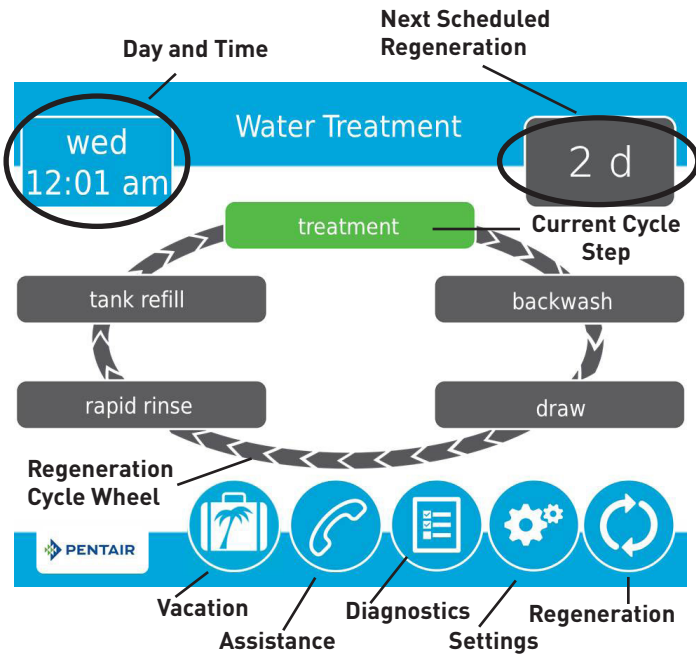

Figure 11 Home Screen

The Home screen is always displayed unless the control settings are being configured or during regeneration. This screen displays general information about the system and allows you to start a manual regeneration or access control settings. Features of the screen are described below, followed by more detailed information about each feature.

**NOTE: If no button is pushed for five minutes, the screen will enter a power save mode. The unit will continue to operate, but the screen will be blank. Touch anywhere on the screen to exit power save mode.**

- **Regeneration:** Press to start a manual regeneration.
- **Settings:** Press to access commonly used settings.
- **Diagnostics:** Press to view diagnostic data.
- **Assistance:** Press to display the name and phone number to call for service.
- **Vacation Mode:** Press to halt all scheduled regenerations; press again to resume normal operation.
- **Regeneration Cycle Wheel:** Displays the cycle steps the valve will step through during a regeneration.
  - **Treatment:** The unit is treating water
  - **Backwash:** Water flows from the bottom of the vessel to the top of the vessel to clean the media
  - **Draw:** Brine is drawn into the media and then slowly rinsed out
  - **Rapid Rinse:** Water flows from the top of the vessel to the bottom of the vessel to rinse the media
  - **Tank Refill:** Brine tank is refilled with water
- **Next Scheduled Regeneration:** Displays the time to next scheduled regeneration, or volume remaining until regeneration in meter systems.

- **Day and Time:** Displays the currently programmed day of the week and time. This button will flash if the control has been reset.

### Regeneration

Regenerate the system on demand by pressing the Regeneration button on the home screen. Manual Regeneration can only be used while the valve is in the treatment position. From the Home screen, press the **Regeneration** button . The Regeneration screen appears.

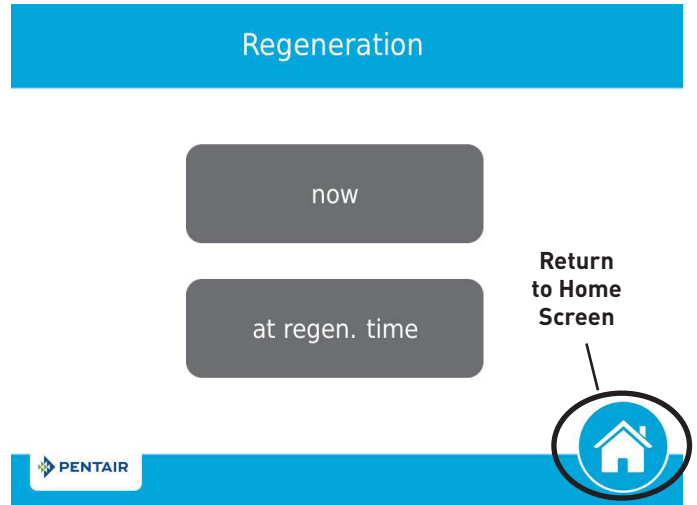

Figure 12 Regeneration Screen

- Press **now** to begin a regeneration immediately, or press **at regen. time** to queue the regeneration for the programmed regeneration time (2:00 AM default for softeners, 12:00 AM default for filters). Pressing **at regen. time** again will cancel the manual regeneration.
- During Regeneration, press the button to immediately advance to the next cycle step. Once in regeneration, the volume or time will be displayed below the .

### Day and Time

From the Home screen (Figure 11) press the Day and Time button. The Day and Time screen (Figure 13) appears.

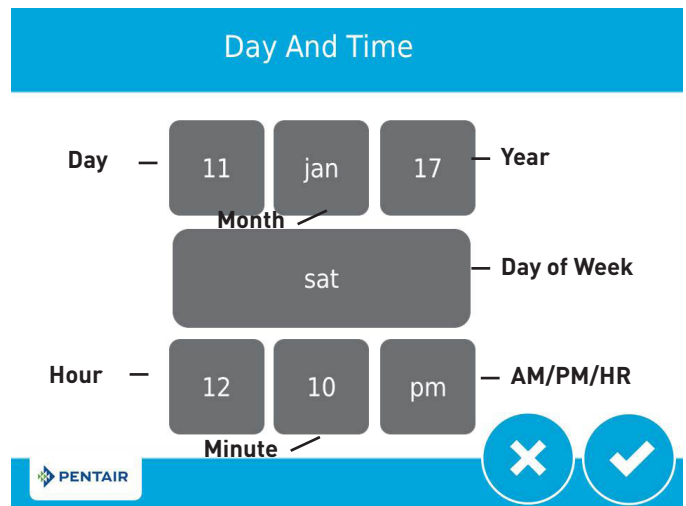

Figure 13 Day and Time Screen

- Press the **Day of Week**, **Hour**, **Minute**, and **AM/PM/HR** buttons to adjust the values to the correct day and time. Setting the value of the **AM/PM/HR** button to HR changes the display to a 24 hour clock. Press the **Day**, **Month**, and **Year** buttons to adjust the values to the correct date. Press the button when finished to return to the Home screen.

## TOUCHSCREEN CONTROL FEATURES

*continued*

### Settings

The Settings screen allows you to change basic control settings including time of regeneration and water hardness. These settings improve the operational efficiency of the system and can be adjusted independently from other control settings without needing to enter Master Settings.

From the Home screen, press the **Settings** button . The Settings screen is displayed.

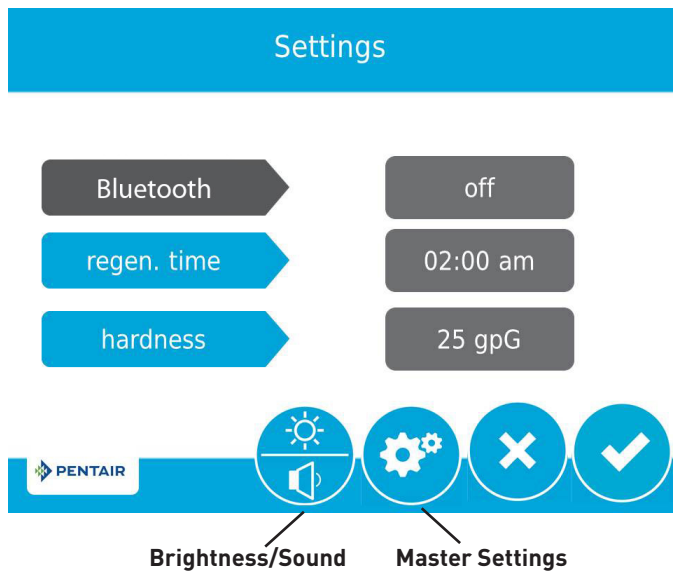



Figure 14 Settings Screen

- Press **day override** to adjust the number of days since last regeneration in which a new regeneration will automatically be run whether one is scheduled or not.
- Press **regen time** to adjust the time of day that an automatic regeneration cycle will begin.
- Press **hardness** to adjust the hardness setting. This value should match the hardness of the incoming untreated water supply.

**NOTE: Changing the hardness setting recalculates treatment volume and regeneration interval. This setting should only be changed on the advice of a professional.**

- Press  to save your changes or press  to return to the Home screen.

Additional features may be accessed from the Settings screen by pressing the buttons at the bottom of the screen (Figure 14):

- **Master Settings:** Displays the Master Settings screen, which allows you to fully program the valve.
- **Brightness/Sound:** Displays the Brightness/Sound screen, which allows you to adjust the backlight of the control screen and allows you to mute the alarms of the control.

**NOTE: Due to the complexity of these settings and the potential for errors, Master Settings should only be accessed by your local water professional.**

**NOTE: Settings can not be accessed during a regeneration. If a regeneration starts while in the settings menu, the screen will return to the main screen and all parameters will be voided.**

### User Assistance

The Assistance screen displays the name and phone number that the homeowner may call for service of the unit. Press the **Assistance** button  from the Master Settings or Home screens. The Assistance screen is displayed.

Assistance/Maintenance

for service or assistance:  
please contact your local  
water professional



Figure 15 Assistance Screen

- This information is entered upon initial control startup (see TOUCHSCREEN CONTROL QUICK START) or can be changed in Master Settings.
- Press the **Home** button  to return to the Home screen.

**NOTE: The Assistance screen is also displayed automatically when the system reaches the programmed assistance interval. See TOUCHSCREEN CONTROL QUICK START.**

### Master Settings

The Master Settings screens include all configurable parameters available in the control.

**CAUTION** Improperly adjusting master settings may cause the system to operate incorrectly. Before entering master settings please contact your professional water dealer.



From the Settings screen, press the Settings button . A warning message appears.

Master Settings

before entering  
master programming  
please contact your local  
water professional



Figure 16 Master Settings Warning Screen

- Press  to continue to the Password screen or press  to return to the Home screen.

# TOUCHSCREEN CONTROL FEATURES

*continued*

The Password screen displays a numeric keypad.

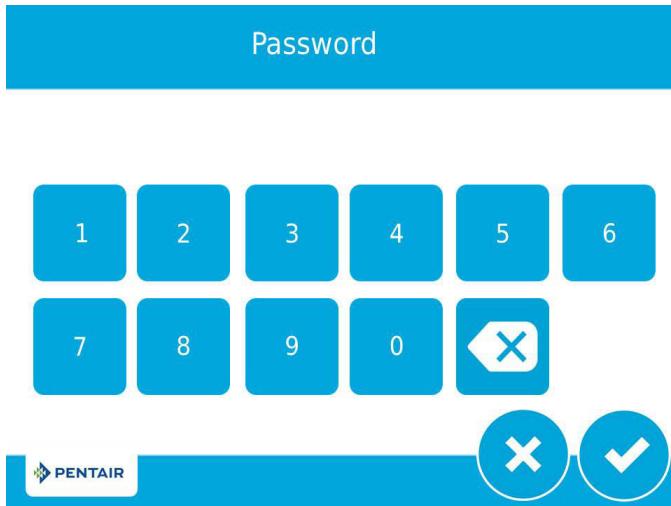

Figure 17 Password Screen

- Enter the master settings password **1201** and press to continue to the main Master Settings screen, or press to return to the Home screen.

After entering the correct password and pressing , the main Master Settings screen is displayed.

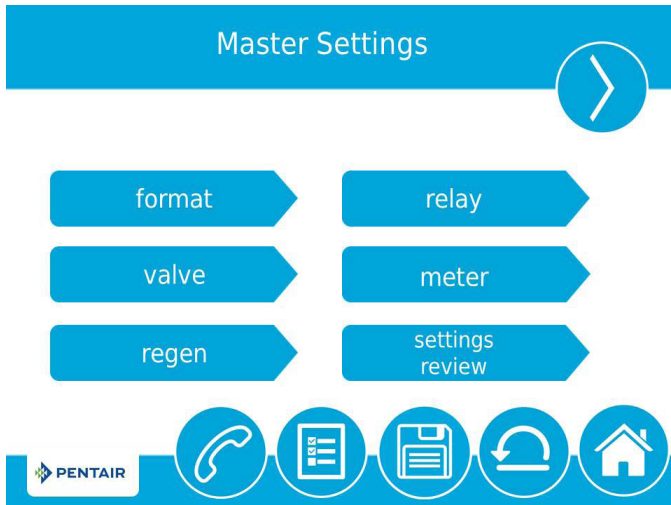

Figure 18 Main Master Settings Screen

While in the Master Settings screens, press to save all set parameters to a custom profile (see "NON-FACTORY SETTINGS" on page 15) or press the **Home** button to return to the Home screen.

Features of the Master Settings screens are described below. See MASTER SETTINGS PROGRAMMING and MASTER SETTINGS REFERENCE CHART for more detailed information.

- **format:** Contains settings for Language, Units, Hardness Units, Assistance Name, Assistance Phone, and Assistance Interval. See TOUCHSCREEN CONTROL QUICK START for more information about these settings.
- **valve:** Contains settings for System, Valve, and Regeneration Type.
- **regen:** Contains settings for Regen Flow.
- **relay:** Contains settings for Aux 1 and Aux 2 relays.
- **meter:** (time clock systems) Contains settings for Meter Types, emergency regeneration.
- **settings review:** Displays a summary of all programmed settings.

Press the screen navigation arrow at the top right of the screen to navigate to the secondary Master Settings screen.

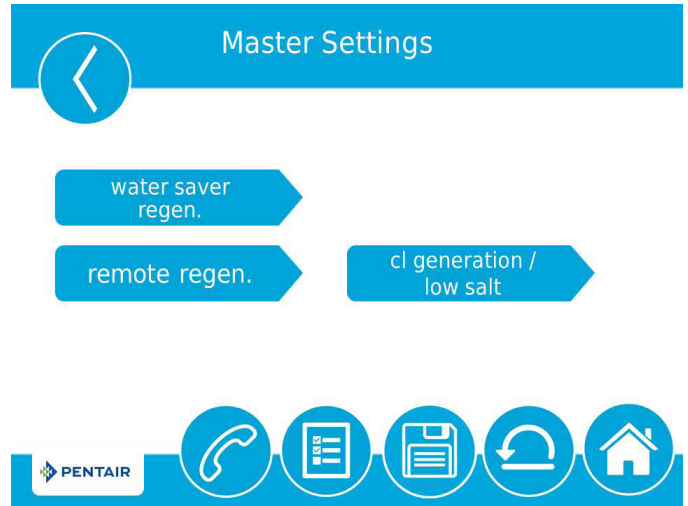

Figure 19 Secondary Master Settings Screen

- **water saver regen:** Contains settings for setting regenerations to save water by reducing backwash and rinse time on a particular interval
- **remote regen:** Contains settings for triggering a regeneration via a remote input
- **cl generation/low salt:** (international version only) Contains settings to trigger chlorine generator for the control

## Water Saver Regeneration

From the secondary Master Settings screen (Figure 19) press the **water saver regen.** button to display the Water Saver Regen screen (Figure 20).

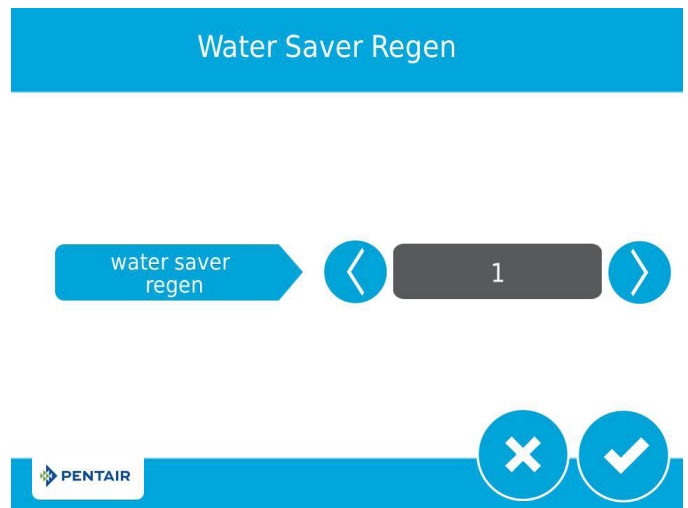

Figure 20 Water Saver Regen Screen

- **water saver regen:** reduces backwash and rapid rinse times on a particular interval. The reduced backwash time is 50% less than the backwash time (rounded down to the nearest minute, e.g. if the backwash time is set to 10 minutes, enabling the water saver regen function will reduce the backwash time to 5 minutes). The reduced rapid rinse time is 66% less than the rapid rinse time (rounded down to the nearest minute, e.g. if the rapid rinse time is set to 10 minutes, enabling the water saver regen function will reduce the backwash time to 3 minutes).
- **range:** 1-25 regenerations (for example, a setting of 3 will produce 1 normal regeneration then 3 reduced water saving regenerations).

## TOUCHSCREEN CONTROL FEATURES

*continued*

### Remote Regeneration Screen

From the secondary Master Settings screen (Figure 19) press the **remote regen** button to display the Remote Regen screen.

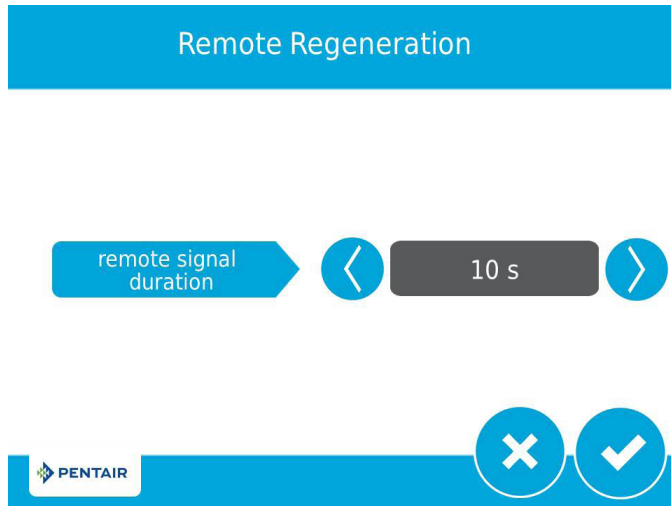

Figure 21 Remote Regeneration Screen

- **remote regeneration duration:** Contains settings for triggering a regeneration via a remote input. Select a value in seconds that the remote switch must be closed in order to trigger the regeneration.

Connect a remote switch (such as a differential pressure switch) to the remote start input terminals on the back of the XTR2 control board. When the remote switch remains closed for the number of seconds specified in the Remote Regen screen, a regeneration will be triggered regardless of volume, capacity, or time remaining until the next scheduled regeneration.

### Chlorine Generation/Low Salt (international version only)

From the secondary Master Settings screen (Figure 19) press the **cl generation/low salt** button to display the Chlorine Gen/Low Salt screen (Figure 22).

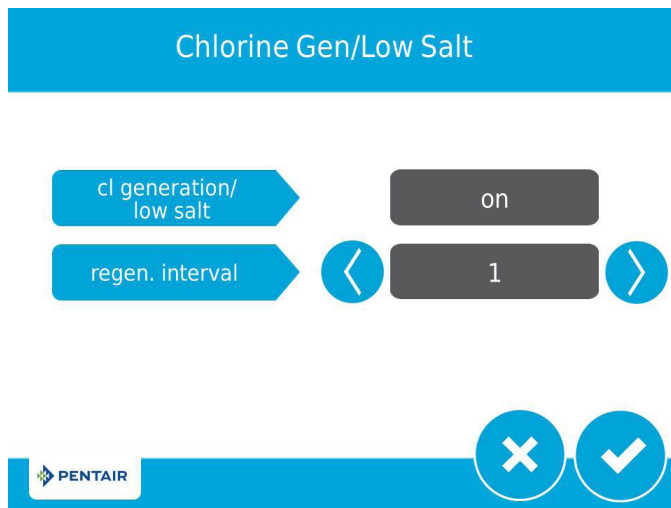

Figure 22 Chlorine Gen/Low Salt Screen

- **cl generation/low salt:** Contains settings to trigger chlorine generator for the control (on/off)
- **regen interval range:** 1 to 255 regenerations

## MASTER SETTINGS PROGRAMMING

**CAUTION** Improperly adjusting master settings may cause the system to operate incorrectly. Before entering master settings please contact your professional water dealer.

**NOTE:** If a regeneration is scheduled to occur while in Master Settings, the scheduled regeneration will be cancelled.

The following is a detailed overview of settings available in Master Settings. Please see the MASTER SETTINGS REFERENCE CHART for the complete set of values and ranges available to program while in Master Settings.

### Format Screen

From the main Master Settings screen (Figure 18) press the **format** button to display the Format screen.

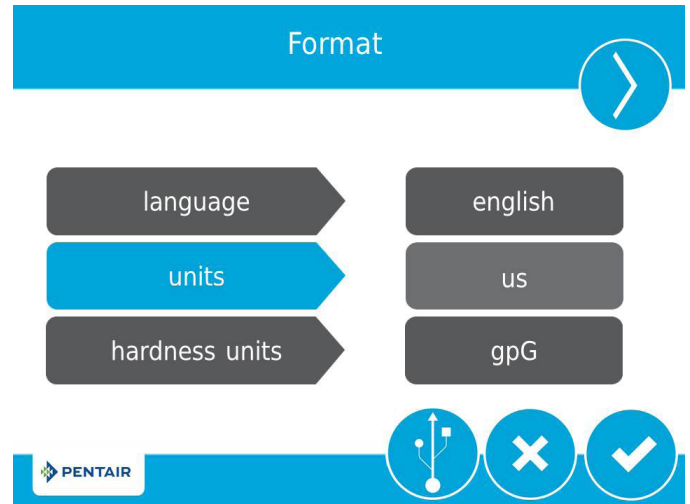

Figure 23 Format Screen

- **language:** Displays the language used on the control (international version only): English, French, German, Italian, Spanish, or Dutch.
  - **units:** Contains settings for the unit type (either US or Metric) to be used in the control.
  - **hardness units:** Contains settings for hardness units of measure (grains per gallon, mg/L or ppm), German degrees, French degrees, or English degrees). Hardness units are adjustable only if metric units are selected.
- NOTE: Degree hardness units are converted to ppm upon input. Degree inputs may be rounded up or down to the nearest ppm equivalent.**
- Press the screen navigation arrows at the upper-right and left of the screen to navigate to the Assistance Name, Assistance Phone, and Assistance Interval screens. See TOUCHSCREEN CONTROL QUICK START for more information about these settings.
  - Press to save changes.

# MASTER SETTINGS PROGRAMMING

*continued*

## Valve Screen

From the main Master Settings screen (Figure 18) press the **valve** button to display the Valve screen.

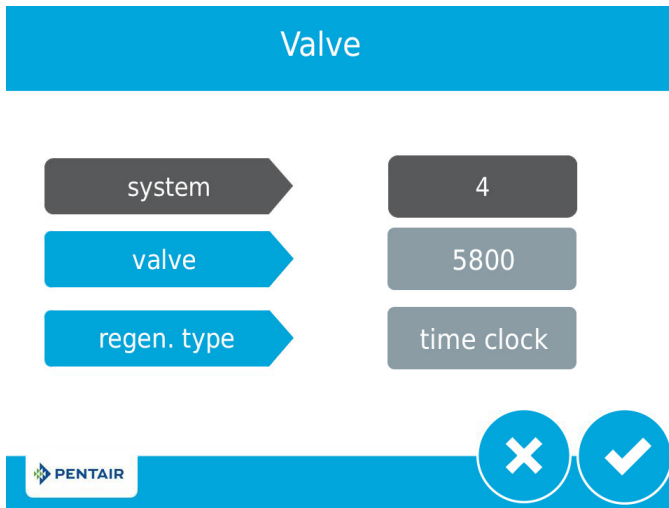

Figure 24 Valve Screen

- **system:** Displays the system type. Type 4 (single system) is currently the only available selection.
- **valve:** Contains settings to select the valve model installed with the control.
- **regen type:** Contains settings for the type of regeneration to use for the system. Regeneration types are described in detail below.

### Regeneration Types

The XTR2 control supports several different Regeneration Types. The Regeneration Type defines the method of automatic regeneration for the system. Each type is explained below.

#### Time Clock

Triggers a regeneration on a timed interval. The control will initiate a regeneration cycle at the selected Regeneration Time when the number of days since the last regeneration equals the Day Override value. The Day Override can be set from 1 - 99 days as well as partial day intervals of 4, 8, 12, 16 and 20 hours.

#### Softener Immediate

Measures water usage and regenerates the system as soon as the calculated system capacity is depleted. The control calculates the system capacity by dividing the unit capacity by the feed water hardness. Softener Immediate systems do not use a reserve volume. The control will also start a regeneration cycle at the programmed regeneration time if a number of days equal to the Day Override pass before water usage depletes the calculated system capacity. The Day Override parameter default is OFF, and REGEN TIME will be grayed out unless the day override value has been modified.

**CAUTION** When setting the system for softener immediate regeneration, setting the capacity to a value lower than that of feed water hardness may cause the system to constantly regenerate. If this occurs, disconnect the motor from the control and correct the capacity and feed water hardness values in Master Settings.

#### Softener Delayed

Measures water usage and regenerates the system at the selected Regeneration Time after the calculated system capacity is depleted. The control calculates the system capacity by dividing the unit capacity by the feed water hardness and subtracting the reserve.

The reserve should be set to ensure that the system delivers treated water between the time the system capacity is depleted and the actual regeneration time. Reserves can be set at a Fixed Volume, Fixed Percentage of capacity, a Variable Reserve based on the previous calendar day's water usage, or a Weekly Reserve based on the average water usage for the current day of the week. The default for the day override parameter is OFF, and the default reserve type is Weekly Reserve.

A Softener Delayed control will also start a regeneration cycle at the selected Regeneration Time if a number of days equal to the Day Override pass before water usage depletes the calculated system capacity.

If the regen type is changed from Softener Immediate to Softener Delayed (or vice-versa), all parameters within those types will be reset to factory default.

#### Filter Immediate

Regenerates the system immediately after the selected Volume Override value is depleted. A Filter Immediate control will also start a regeneration cycle at the selected Regeneration Time if a number of days equal to the Day Override pass before water usage depletes the calculated system capacity.

#### Filter Delayed

Regenerates the system at the selected Regeneration Time after the selected Volume Override value is depleted. A Filter Delayed control will also start a regeneration cycle at the selected Regeneration Time if a number of days equal to the Day Override pass before water usage depletes the calculated system capacity.

**NOTE:** If Filter Immediate or Filter Delayed are selected, Regenerant Flow selections are limited to Filter, Upflow Filter, Custom Filter, and Custom Upflow Filter.

## Regeneration Screen

From the main Master Settings screen (Figure 18) press the **regen** button to display the Regeneration screen.

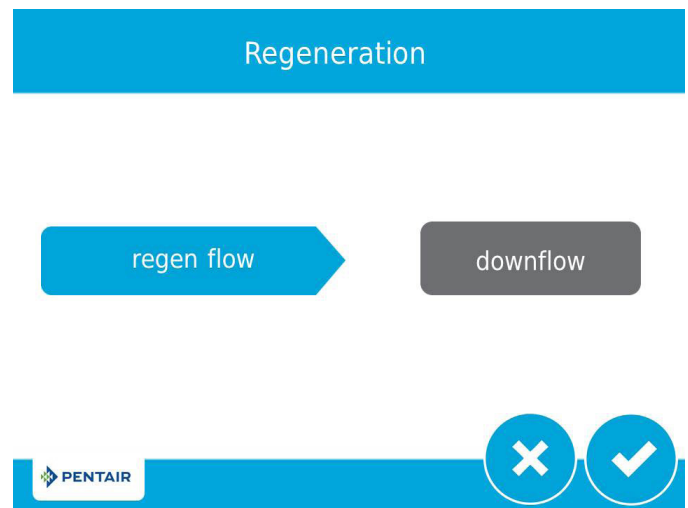

Figure 25 Regeneration Screen

**CAUTION** Adjusting Regeneration settings will turn any set relays off. Any required relays will need to be reprogrammed in the Relay Output screen.

# MASTER SETTINGS PROGRAMMING

*continued*

- **regen flow:** Contains settings for the type of regenerant flow to be used in the valve. Changes to this setting affects the cycle steps displayed in the Regeneration Cycle Wheel on the Home screen. Regenerant flow cycle steps are described below. See TOUCHSCREEN CONTROL FEATURES for cycle step definitions.
- **downflow:** Cycle steps are as follows: Backwash, Draw, Rapid Rinse, Tank Refill
- **upflow:** Cycle steps are as follows: Draw, Backwash, Rapid Rinse, Tank Refill
- **downflow 2X backwash:** Cycle steps are as follows: Backwash, Draw, Backwash, Rapid Rinse, Tank Refill
- **custom upflow / downflow / filter:** Allows for up to 20 programmable cycle steps.
- **variable refill:** (softener delayed only) Cycle steps are as follows: Refill, Pause, Draw, Backwash, Rinse. Variable refill calculates refill time based on salt dosage, media volume, and BLFC size.

## Relay Output Screen

From the main Master Settings screen (Figure 18) press the **relay** button to display the Relay Outputs screen.

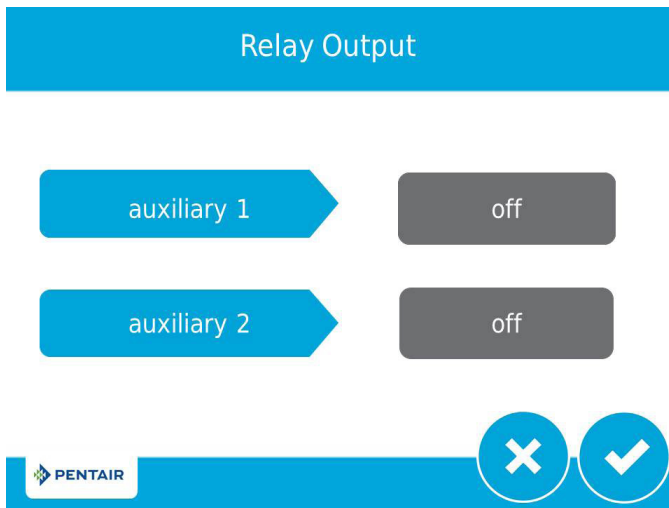

Figure 26 Relay Outputs Screen

- **auxiliary 1 / auxiliary 2:** Contains settings for programming up to two auxiliary relay outputs. There are three types of relays that can be programmed:
  - **Cycle Based:** The relay will turn on when the valve moves to the specified regeneration cycle steps. To program, select each cycle step button for which the relay should turn on.
  - **Time Based:** The relay will turn on and off at up to two specified start and end times. If water saving regeneration is on, this is not an available option.
  - **Volume Based:** The relay will turn on when the valve has treated a specified volume of water. Duration can be set for up to two hours.
  - **Alarm Based:** The relay will turn on when the specified alarm condition (or any alarm condition) is met. The relay will turn off when the alarm is cleared.

## Meter Screen

From the main Master Settings screen (Figure 18) press the **meter** button to display the Meter screen.

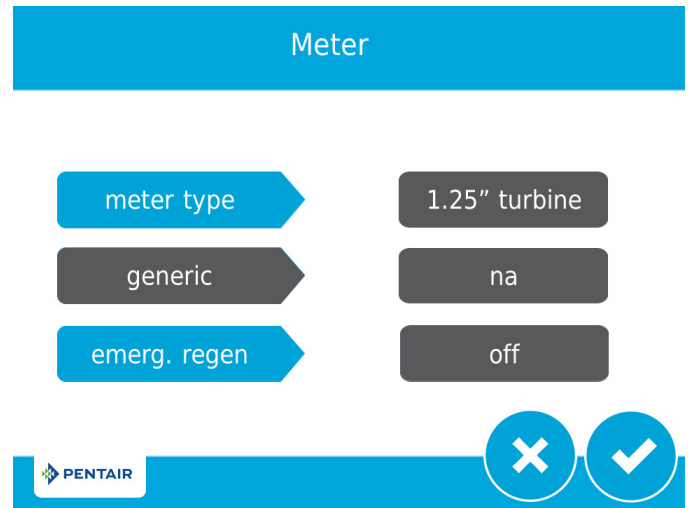

Figure 27 Meter Screen

- **meter type:** Contains settings for the type of meter installed with the system. The 5810/5812 valve uses an internal 1.25" turbine meter.
- **generic:** A generic option is available if the installed meter does not match any other selection. Requires setting the number of pulses per volume to ensure proper metering.
- **emergency regen:** When on, the emergency regen feature causes a regen to occur immediately when 105% or greater of the capacity (e.g., volume plus reserve) is used.

## Continuous Flow Detect Screen

From the Master Settings screen (Figure 18) press  the button to display the Continuous Flow Detect screen.

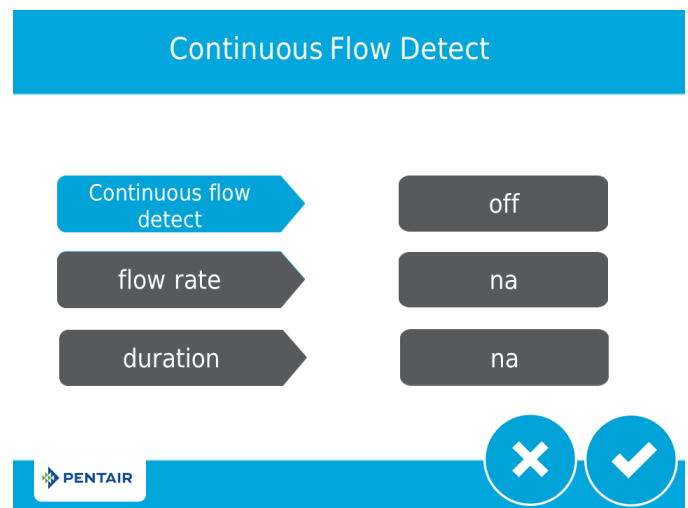

Figure 28 Continuous Flow Detect Screen

- **continuous flow detect:** When active, triggers an alarm when continuous flow of 0.5 GPM or 1 LPM is detected by the flow meter over an 8-hour period.

# MASTER SETTINGS PROGRAMMING

*continued*

## Settings Review

From the main Master Settings screen (Figure 18) press the settings review button to display the Settings Review screens, which display a read-only summary of all programmed settings in the control.

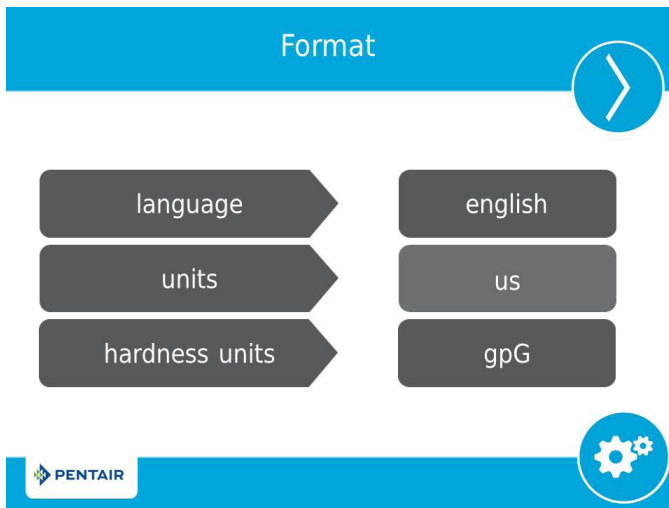

Figure 29 Format Settings Review Screen

Use the navigation arrows at the top of the screen to scroll through the parameters currently set in the control. The Settings Review screens are formatted similarly to the corresponding screen where each parameter was set. Press to return to Master Settings.

## Non-Factory Settings

After all parameters in Master Programming have been set, these settings can be saved to a custom profile by pressing on the main Master Settings screen (Figure 18). After pressing , the Non-Factory Settings screen appears.

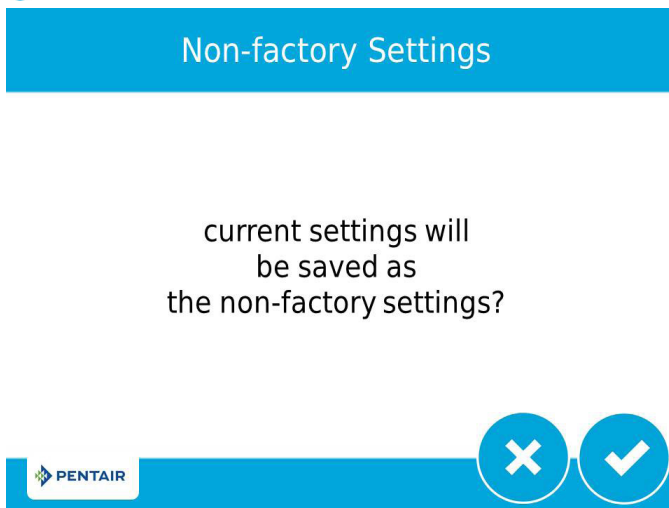

Figure 30 Non-Factory Settings Screen

Press to save all programmed Master Settings parameters to non-factory settings. At any point, the control can be reset to these saved custom settings. By performing a custom reset, any setting that is subsequently programmed without saving to non-factory settings will be reset to the previously saved non-factory settings in the control.

## Diagnostics

The control records and displays a variety of diagnostic data to assist with troubleshooting performance issues and fine-tuning system efficiency. Press the **Diagnostics** button from the Master Settings or Home screens to view the Diagnostic screen.

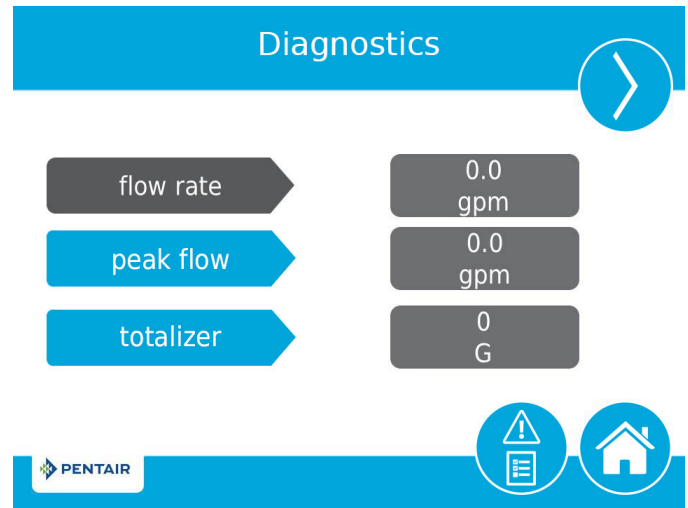

Figure 31 Diagnostic Screen

- Press the screen navigation arrows at the upper-right and left of the screen to view each diagnostic parameter.
- Press the **Error Log** button to access the Error Log screen. To clear the Error Log, press the **Reset** button then the **Reset** button again on the Clear All Error Logs screen, then enter "1201" at the password prompt screen, then press the Accept button to confirm.

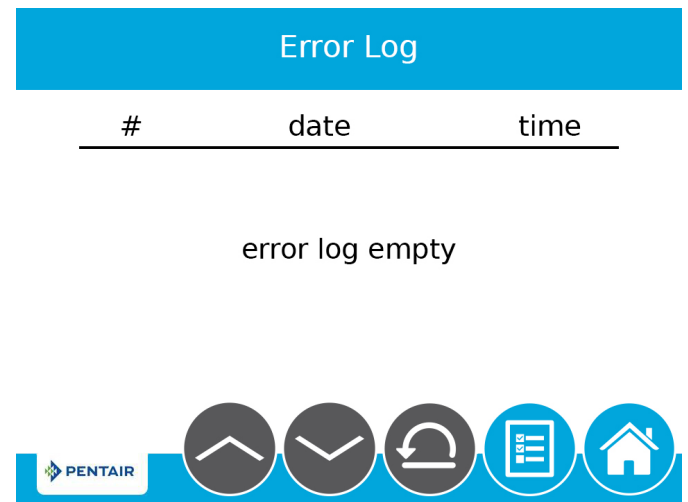

Figure 32 Error Log Screen

- Press the **Home** button to return to the Home screen.

# MASTER SETTINGS PROGRAMMING

*continued*

**NOTE: If a regeneration occurs while in the Diagnostic screen, the unit will return to the main screen.**

| Parameter           | Description   |
|---------------------|---|
| Flow Rate           | Displays the current flow rate.   |
| Peak Flow           | Displays maximum flow rate of water along with date and time of occurrence, since last reset.   |
| Totalizer           | Displays total volume of water used since last reset.   |
| Last Regen          | Displays when last regeneration occurred.   |
| Reserve             | Displays the reserve volume based on the reserve type selected under master settings.<br><br>*This parameter is only available for meter delayed regeneration type. |
| Software Version    | Displays the software version installed on the controller.  |
| No of Regens        | Displays how many manually and system initiated regenerations the system has gone through since last reset.   |
| Regen Interval      | Displays the average length of time between regenerations based on the past four regenerations.   |
| Daily Usage         | Displays average water usage for each day of the week based on the usage on that day for the past six weeks.  |
| Usage Since Regen   | Displays water usage since last regeneration.   |
| Last Setting Change | Displays the date and time of the last update to Master Settings.   |

**NOTE: Only Peak Flow and Totalizer can be changed - they can be reset to zero.**

**NOTE: Totalizer has a maximum value of 99,999,999. If this number is reached, the Totalizer must be reset to zero to continue tracking this value.**

## USB Connection for Field Programming

The XTR2 features a USB port that allows you to connect a PC to the control for field programming and diagnostic parameter download.

**NOTE: Field Programmer software is required for field programming features. See XTR2 Field Programmer Manual for more information on using the Field Programmer software.**

Pressing  on the Format screen displays the USB screen.

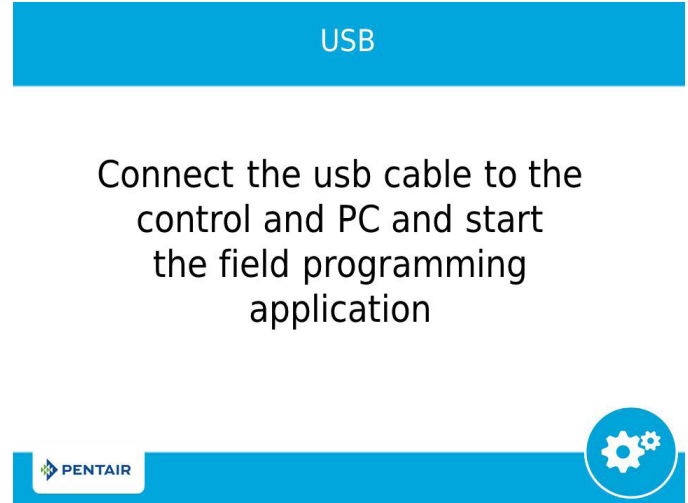



Figure 33 USB Screen

When the USB screen appears, connect a USB cable to the USB port on the control circuit board. Connect the other end of the USB cable to a PC with the Field Programmer software installed and follow the directions in the XTR2 Field Programmer manual to complete the connection. Press  to return to Master Settings.

**NOTE: Do not remove USB cable from computer or control while connected and transferring data. See the XTR2 Field Programmer manual for proper disconnection procedure.**



## MASTER RESET

Press the  button while in the Master Settings main screen (Figure 18) to display the Reset screen.

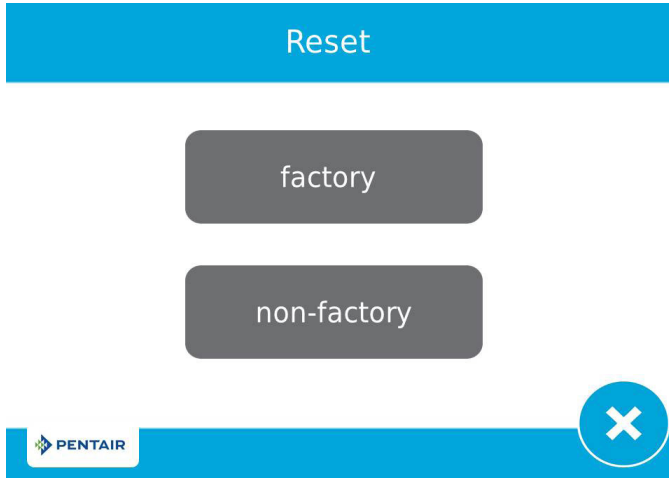







Figure 34 Reset Screen

Press the **factory** button to reset all control parameters to their factory defaults, or press the **non-factory** button to reset control parameters to previously saved custom settings (see "NON-FACTORY SETTINGS" on page 15). A warning screen appears before parameters are reset. Press  to confirm the reset or press  to return to Master Settings.

## CONTROL OPERATION

### Control Operation During Regeneration

During regeneration, the Regeneration Cycle Wheel shows the regeneration step the valve is advancing to, or has reached, and the time remaining in that step. Once all regeneration steps are complete the valve returns to treatment position and resumes normal operation. The time remaining in regeneration will be displayed on the home screen in hours and minutes.

Pressing the  button during a regeneration cycle immediately advances the valve to the next cycle step position and resumes normal step timing. The  button is only shown when the valve is in position and the motor has stopped. Pressing the  button will cancel the regeneration.

### Control Operation During Programming

The control can only be programmed with the valve in treatment. While being programmed the control continues to operate normally, monitoring water usage and keeping all displays up to date. Control programming is stored in memory permanently until reset.

### Control Operation During a Power Failure

The XTR2 includes internal power backup. In the event of power failure, the control shifts into a power-saving mode. The control stops monitoring water usage. The display and motor shut down, but it continues to keep track of the time and day for a minimum of eight hours. The system configuration settings are stored in a non-volatile memory and are stored indefinitely with or without power. After a long power outage, the Time of Day button may flash indicating it needs to be reset. Press the button to stop the Time of Day from flashing and reset time if needed. If power fails while the unit is in regeneration, the control will save the current valve position before it shuts down. When power is restored, the control will resume the regeneration cycle from the point where power failed. If power remains off for more than eight hours, upon power restoration the regeneration is canceled and the piston returns to service.

**CAUTION** If power fails during a regeneration cycle, the valve will remain in its current position until power is restored. The valve system should include all required safety components to prevent overflows resulting from a power failure during regeneration.

The control will not start a new regeneration cycle without power. If the valve misses a scheduled regeneration due to a power failure, it will queue a regeneration. Once power is restored, the control will initiate a regeneration cycle the next time that the Time of Day equals the programmed regeneration time. Typically, this means that the valve will regenerate one day after it was originally scheduled. If the treated water output is important and power interruptions are expected, the system should be set up with a sufficient reserve capacity to compensate for regeneration delays.

### Remote Lockout



If a remote switch is installed, the control will not allow the system to go into regeneration until the regeneration lockout input signal to the control is cleared. This requires opening the contact closure to clear the lockout condition. The recommended gauge wire is 20 with a maximum length of 500 feet. See "WIRING DIAGRAM" on page 32.

### Sleep Mode

The control will go into sleep mode if no button is pressed after five minutes. All other control functions will continue to operate. The display will wake from sleep mode when any part of the display is touched.

## ALARMS AND ERRORS

If an error in valve or control function occurs, an alarm will sound and the Home screen will display the Error

Alert button  and the Alarm button .

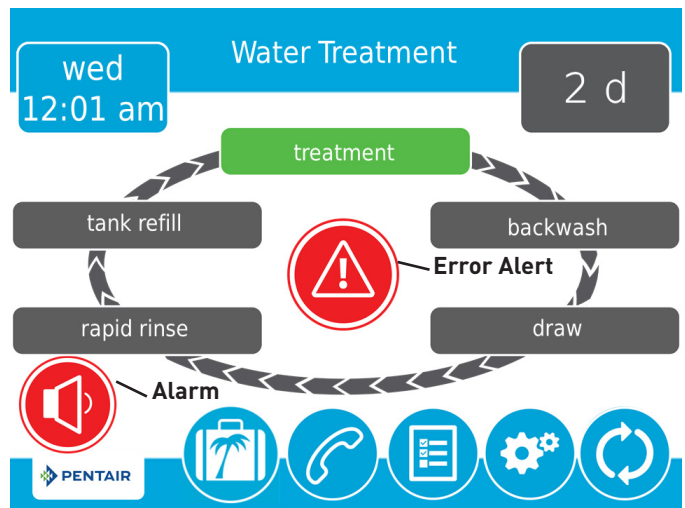

Figure 35 Alarm and Error Alert

- Press the **Alarm** button to mute the alarm.
- Press the **Error Alert** button to view information about the error.

If the display is in sleep mode when an error occurs, the screen will turn on for five minutes. The error will beep for one second per minute until the error is cleared. If the error is not cleared after five minutes, the screen will switch to power saving mode and display the Error Alert button as a screen saver.

See TROUBLESHOOTING for more information about error conditions.

# MASTER SETTINGS REFERENCE CHART

**CAUTION** Before entering Master Settings, please contact your local professional water dealer.

| Screen Name         | Parameters                 | Values   | Notes   |
|---------------------|----------------------------|--|---|
| Format              | Language                   | English, French, German, Italian, Spanish, Dutch   | Changes the language to display screen text and button labels in the control (available with international version of control only).  |
|                     | Units                      | U.S.<br>Metric   | Changes system units and values across all parameters in the control. All programmed units and values should be recalculated after adjusting this setting.  |
|                     | Hardness Units             | Grains per gallon<br>mg/L or ppm<br>German degrees<br>French degrees<br>English degrees  | Changes hardness units used in displaying hardness parameters and calculating system capacity and editing exchange capacity and hardness settings.  |
| Assistance Name     | Free-form text             | A - Z and space  | Name of service provider to display when viewing the Assistance screen. 20 character limit.   |
| Assistance Phone    | Free-form text             | 0 - 9 and space  | Phone number of service provider to display when viewing the Assistance screen. 20 character limit.   |
| Assistance Interval | Month Based<br>Regen Based | 1 - 60<br>1 - 2000<br>Off  | Set to automatically display the Assistance screen after a certain number of months or regenerations.   |
| Valve               | System                     | 4  | System 4 (single system) is currently the only available selection.   |
|                     | Valve                      | 5800<br>5810<br>5812   | Select the type of valve to be installed.   |
|                     | Media Volume               | 0.25 - 999.00 ft <sup>3</sup><br>1 - 9999 L  | Used to calculate capacity.   |
|                     | Salt Dosage                | 3 - 18 lbs/ft <sup>3</sup><br>50 - 290 g/L   | Used to calculate capacity and refill time.   |
|                     | BLFC size                  | 0.125 gpm<br>0.250 gpm<br>0.500 gpm<br>1.000 gpm   | Brine Line Flow Control; Used to calculate refill time.   |
|                     | Regen. Type                | Time Clock<br>Softener Immediate<br>Softener Delayed<br>Filter Immediate<br>Filter Delayed   | Regeneration Types are described in detail on page 13. Additional Valve screen parameters are dependent upon selected Regeneration Type. Not all parameters will be displayed. Softener Delayed regeneration type has four reserve options (Fixed %, Fixed Volume, Variable Reserve, Weekly Reserve). The control will display additional configuration options depending on the selected reserve type.   |
|                     | Capacity                   | 1 - 99 999 999<br>grains / grams / degrees   | Only required on metered systems to calculate treated water capacity and reserve. Represents total system capacity between regenerations.   |
|                     | Hardness                   | 1 - 199 grains/gallon<br>1 - 1 999 mg/liter<br>x - x degrees   | Only required on metered systems to calculate treated water capacity and reserve. Represents hardness of untreated water.   |
|                     | Reserve                    | Fixed %<br>Fixed Volume<br>Weekly Reserve<br>Variable Reserve  | Only available when Meter Delayed regeneration type is selected. Selecting Fixed % or Fixed Volume will display additional configuration options. Weekly Reserve is calculated based on average day of week's water usage. Variable Reserve is calculated based on previous day's water usage.  |
|                     | Day Override               | 1 - 99 days<br>4, 8, 12, 16, 20 hours  | Available to be programmed for all Regeneration Types.  |
|                     | Regen Time                 | 12 / 24 hour clock   | Required for Time Clock and delayed Regeneration Types. Set for immediate regeneration types only when a Day Override is also set.  |
|                     | Volume Override            | 1 - 99 999 999 gallons / liters  | Only displayed when Regeneration Type is Filter Immediate or Filter Delayed.  |
| Regeneration        | Regen. Flow                | Upflow<br>Downflow<br>Downflow 2x Backwash<br>Filter<br>Custom Upflow/Downflow/Filter<br>Variable Refill   | Cycle steps on the Home screen and during regeneration will change to reflect the cycle steps and order in the selected Regenerant Flow. Additional Regeneration screen parameters are dependent upon selected Regenerant Flow. Not all parameters will be displayed. Custom Upflow and Downflow allows for up to 20 programmable cycle steps. Variable Refill calculates refill time based on Salt Dosage, Media Volume, and BLFC Size. Time per cycle step can be programmed for all other Regenerant Flow options.   |
| Relay Outputs       | Aux 1/Aux 2                | Cycle Based<br>Time Based<br>Volume Based<br>Alarm Based<br>Off  | For Cycle Based relays, select the cycle steps on which the relays will turn on. For Time Based relays, two start/end times will need to be selected for each relay. Relay times are based on total regeneration cycle time. Volume Based relays can be programmed from zero gallons/liters to the full system capacity. Duration can be set from zero seconds to two hours. Volume Based option is not available when Regeneration Type is set to Time Clock. Alarm Based relays will turn on when an alarm condition is met, and will turn off when the alarm is cleared. |
| Meter               | Meter Type                 | .75 inch Paddle<br>1.00 inch Paddle<br>1.25 inch Turbine<br>1.50 inch Paddle<br>1.50 inch Turbine<br>2.00 inch Paddle<br>3.00 inch Paddle<br>Generic | Select the type of meter installed with the system. A Generic option is available if the installed meter does not match any other selection. Selecting the Generic meter type requires setting the number of pulses per gallon or liter to ensure proper metering.  |
|                     | Generic                    | 1 - 999.9 / 1 - 1500<br>pulses per gallon / liter  | Only available when Generic meter type is selected.   |
| Remote Regen        | Remote Regen               | 1 - 255 seconds<br>Off   | Select a value in seconds that the remote switch must be closed in order to trigger the regeneration.   |

**NOTE:** Some items may not be shown depending on control configuration. The control will discard any changes and exit Master Settings if any button is not pressed for five minutes.

## TROUBLESHOOTING

| Problem                      | Cause   | Correction   |
|------------------------------|---|--|
| Valve constantly regenerates | Error in programming has caused a regeneration loop condition in the control. | Disconnect the motor from the control circuit board (see "WIRING DIAGRAM" on page 32 for location on circuit board). A Motor Stall error will occur, allowing access to Master Settings. Navigate to the Valve screen and check Regen Type settings. Ensure that the value for Capacity is larger than the value for Hardness, and save settings.<br><br>If the error continues to occur, unplug the unit, put it into bypass and contact technical support. |

### Error Alerts

**NOTE:** An Error Alert appears on the Home screen if an error condition is detected. Press the Error Alert button  to view the error message.

**NOTE:** Most error alerts are cleared at regeneration. If the error persists following a regeneration attempt the appropriate reset and recovery procedure below or contact technical support.

| Error Screen Display   | Cause   | Reset and Recovery   |
|--|---|--|
| Motor Stall<br>Motor Run-On<br><br>No changes detected in the optical sensor for 6 seconds | No state changes in the optical sensor are detected for six seconds.              | Unplug the unit and plug back in. Allow the control to attempt to find position again.<br><br>Verify the optical sensor is in place with the wires connected to the circuit board. Verify the motor and drive train components are in good condition and assembled properly. Check the valve and verify that the piston travels freely. Replace/reassemble the various components as necessary.<br><br>Plug the unit back in and observe its behavior. If the error reoccurs, unplug the unit, put it into bypass and contact technical support. |
| Optical Sensor<br>Undesired change detected in the optical sensor                          | An undesired optical sensor state change occurred.                                | Non-critical error. Extra optical sensor pulse detected. Press the Regeneration button to advance motor to clear error.  |
| Flow meter error<br>Continuous Flow  | The flow meter has reported continuous flow for more than 24 hours.               | Error will clear when flow to meter drops below 0.5 GPM or 1 LPM. If continuous flow is expected, turn plumbing leak detection off in Master Settings.   |
| Over current<br>Motor over current detected  | Motor drew too much current   | Attempt to perform a manual regeneration. If error continues, call technical support.  |
| Flow meter error<br>No flow detected   | No flow has been detected for 7 days.   | Error will clear when a flow pulse is detected. Check to ensure meter cable is properly installed and meter spins freely. Clear meter of debris if necessary. If error continues, call technical support.  |
| No regeneration for 100 days   | The valve has not regenerated in more than 100 days.                              | Initiate a regeneration.   |
| Service Interval   | Service Interval timer has expired.   | From within Master Settings, navigate to the Assistance/Mainten. Interval screen and set a new Service Interval time.  |
| Memory Corruption<br>Error   | Internal memory inconsistent or corrupted   | 1. Cycle power to XTR2 controller<br>2. Drain supercap and cycle power to XTR2 controller.<br>3. If error continues, call technical support.   |
| No Salt Detect<br>(international version only)   | When chlorine generator is on but does not read salt from the chlorine generator. | Error will clear if salt is added to the brine tank and a manual regeneration is performed.  |
| Emergency Regen Occured  | Over 105% of the total capacity (e.g., volume plus reserve) has been depleted     | Error will clear when regeneration occurs. When the Emergency Regen is enabled, the Emergency Regen Occured error alert will display to let the user know an Emergency Regen occurred. Repeated Emergency Regens may indicate an undersized system.  |

## 5800 XTR2 CONTROL VALVE ASSEMBLY

| Item No. | QTY | Part No.   | Description   |
|----------|-----|------------|---|
| 1        | 1   | 580008-001 | Turbine Meter, Downflow Softener, U.S. Power Supply, #00 Injector, 0.125 GPM BLFC |
|          |     | 580008-002 | Turbine Meter, Upflow Softener, INT'L Power Supply, #00 Injector, 0.125 GPM BLFC  |
|          |     | 580008-003 | Time Clock B/W Filter, U.S. Power Supply  |

**NOTE:** Above part numbers DO NOT include the following parts.

Bezel  
Bypass Assembly  
Connector Assembly  
Flow Washer  
DLFC

See 5800 accessories page for options.



# 5800 CONTROL VALVE ASSEMBLY

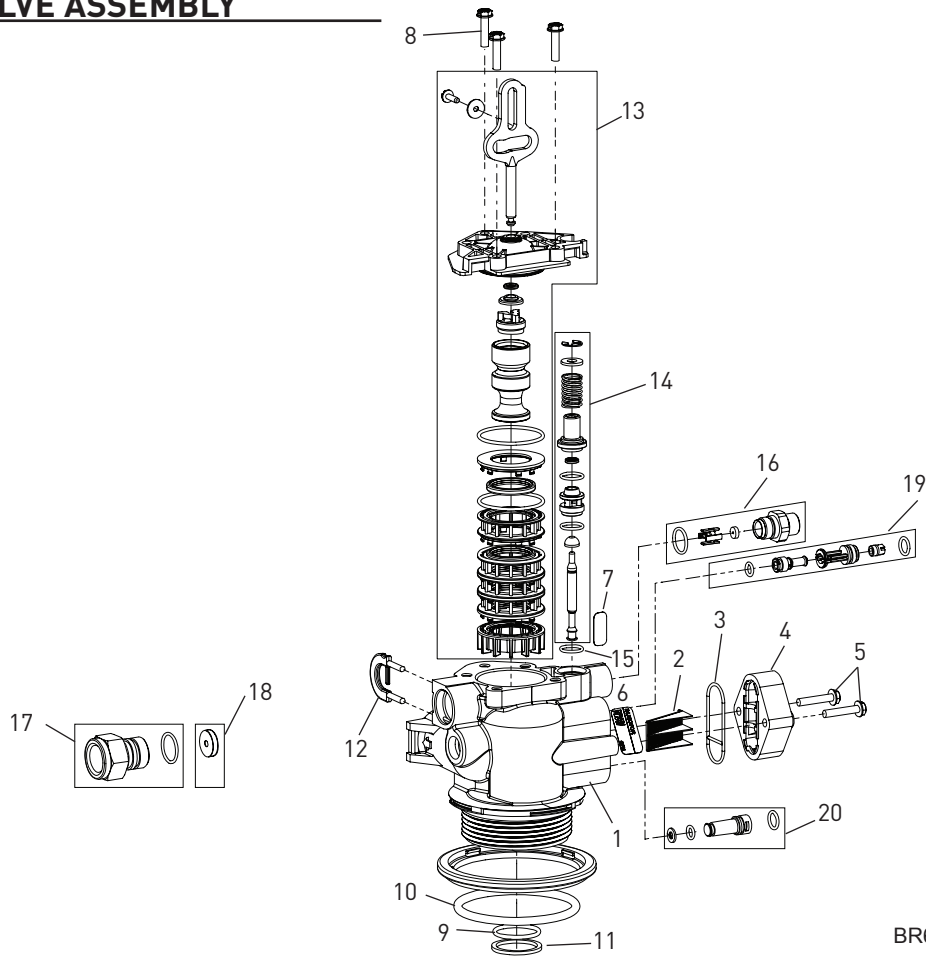

BR61500-5800 Rev A

| Item No. | QTY | Part No.  | Description   |
|----------|-----|-----------|---|
| 1        | 1   | 61857-01  | Valve Body Assy, Downflow/Upflow (Includes Items 9, 10, 11, 12)         |
|          |     | 61857-20  | Valve Body Assy, Mixing, Downflow/Upflow (Includes Items 9, 10, 11, 12) |
| 2        | 1   | 18271     | Screen Injector, 5800   |
| 3        | 1   | 40064     | Seal Injector   |
| 4        | 1   | 18277     | Cap Injector  |
|          |     | 18278-20  | Injector Cap Assy, 1610 Regulated, 5800, 20 psi, Black, Upflow          |
|          |     | 18278-30  | Injector Cap Assy, 1610 Regulated, 5800, 30 psi, Gray, Upflow           |
| 5        | 2   | 18262     | Screw, Hex Washer Head, #10-24 x 1.00                                   |
| 6        | 1   | 19654     | Label, 0.125 gpm Brine Flow   |
|          |     | 12128     | Label, 0.25 gpm BLFC  |
|          |     | 10759     | Label, 0.5 gpm 1.5 lbs Salt/Min   |
|          |     | 10760     | Label, 1.0 gpm 3 lbs Salt/Min   |
| 7        | 1   | 13333     | Label, Injector, Blank  |
| 8        | 3   | 18261     | Screw, Hex Washer Head, #10-24 0.81                                     |
| 9        | 1   | 13304     | O-ring, -121  |
| 10       | 1   | 18303-01  | O-ring, -336, 560CD   |
| 11       | 1   | 13030     | Retainer, Distributor Tube O-ring                                       |
| 12       | 1   | 18312     | DLFC Housing Retainer Clip  |
| 13       | 1   | 61837     | Piston and Seal Kit Assy, Downflow, 5800                                |
|          |     | 61838     | Piston and Seal Kit Assy, Upflow, 5800                                  |
| 14       | 1   | 60032     | Brine Valve, 4600/5600  |
| 15       | 1   | 13302     | O-ring, -014  |
| 16       |     | 60022-12  | BLFC, 0.125 gpm   |
|          |     | 60022-25  | BLFC, 0.25 gpm  |
|          |     | 60022-50  | BLFC, 0.5 gpm   |
|          |     | 60022-100 | BLFC, 1.0 gpm   |
| 17       |     | 60705-00  | DLFC, Plastic, Blank  |
|          |     | 60706-8.0 | DLFC, QC x 3/4" F, 8.0 GPM  |
|          |     | 60706-9.0 | DLFC, QC x 3/4" F, 9.0 GPM  |
|          |     | 60706-10  | DLFC, QC x 3/4" F, 10 GPM   |
|          |     | 60706-12  | DLFC, QC x 3/4" F, 12 GPM   |
|          |     | 60706-15  | DLFC, QC x 3/4" F, 15 GPM   |
| 18       |     | 19153     | Washer, Flow, 0.6 GPM   |
|          |     | 19152     | Washer, Flow, 0.8 GPM   |
|          |     | 12085     | Washer, Flow, 1.2 GPM   |
|          |     | 19150     | Washer, Flow, 1.3 GPM   |
|          |     | 12086     | Washer, Flow, 1.5 GPM   |
|          |     | 12087     | Washer, Flow, 2.0 GPM   |
|          |     | 12088     | Washer, Flow, 2.4 GPM   |
|          |     | 12089     | Washer, Flow, 3.0 GPM   |
|          |     | 12090     | Washer, Flow, 3.5 GPM   |
|          |     | 12091     | Washer, Flow, 4.0 GPM   |
|          |     | 19147     | Washer, Flow, 4.5 GPM   |
|          |     | 12092     | Washer, Flow, 5.0 GPM   |
|          |     | 17814     | Washer, Flow, 6.0 GPM   |
|          |     | 12408     | Washer, Flow, 7.0 GPM   |
| 19       |     | 18272-000 | Injector Assy, 1610, #000, Brown  |
|          |     | 18272-00  | Injector Assy, 1610, #00, Violet  |
|          |     | 18272-0   | Injector Assy, 1610, #0, Red  |
|          |     | 18272-1   | Injector Assy, 1610, #1, White  |
|          |     | 18272-2   | Injector Assy, 1610, #2, Blue   |
|          |     | 18272-3   | Injector Assy, 1610, #3, Yellow   |
| 20       |     | 18276-01  | Injector Assy, Plug, w/O-rings  |

**Not Shown:**

- 40947-01 Plug, Brine Valve, w/O-ring, 560CD
- 13918-01 BLFC Module Plug Assy, w/O-ring

**NOTE:** In upflow units, the Injector Plug and Injector Assy are put in the reverse holes. In filter units, both injector holes are plugged with 18276-01.

**CAUTION** Excessive side load on piston rod may cause premature failure.

**CAUTION** If seal/spacer stack is stuck in valve bore during disassembly, rotate stack prior to removal.

## 5800 VALVE ACCESSORIES

### Covers

|       |       |                                 |
|-------|-------|---------------------------------|
| 43261 | ..... | Cover, 5800                     |
| 43715 | ..... | Cover, 5800, Lower              |
| 61882 | ..... | Cover Assy, 5800, Environmental |

### Bezels

|          |       |               |
|----------|-------|---------------|
| 43262-00 | ..... | Bezel, Blue   |
| 43262-01 | ..... | Bezel, Black  |
| 43262-02 | ..... | Bezel, Silver |

### Bypasses

|         |       |                      |
|---------|-------|----------------------|
| 60040SS | ..... | 3/4" Bypass, SS, NPT |
| 60041SS | ..... | 1" Bypass, SS, NPT   |
| 60049   | ..... | Bypass, Plastic      |

### Collectors

|          |       |                             |
|----------|-------|-----------------------------|
| 18280    | ..... | Top Collector, 1.050        |
| 18280-01 | ..... | Top Collector, 1.050 Wide   |
| 18280-02 | ..... | Top Collector, 1.050 Narrow |

### Yokes

|          |       |                                   |
|----------|-------|-----------------------------------|
| 19620-01 | ..... | Yoke Assy, 3/4", r/angle, 90 deg. |
| 18706    | ..... | 1" Yoke, Plastic NPT              |
| 18706-02 | ..... | 3/4" Yoke, Plastic NPT            |
| 18706-10 | ..... | 1" Yoke, Plastic BSP              |
| 18706-12 | ..... | 3/4" Yoke, Plastic BSP            |
| 61694    | ..... | 1" Yoke, QC                       |
| 61700    | ..... | 3/4" Yoke, QC                     |
| 13708-40 | ..... | 1" Yoke, Sweat                    |
| 41026-01 | ..... | 1" Yoke, SS, NPT                  |
| 42690    | ..... | 3/4" Yoke, Sweat                  |
| 41027-01 | ..... | 3/4" Yoke, SS, NPT                |

### Washers

|       |       |                       |
|-------|-------|-----------------------|
| 19153 | ..... | Washer, Flow, 0.6 GPM |
| 19152 | ..... | Washer, Flow, 0.8 GPM |
| 12085 | ..... | Washer, Flow, 1.2 GPM |
| 19150 | ..... | Washer, Flow, 1.3 GPM |
| 12086 | ..... | Washer, Flow, 1.5 GPM |
| 12087 | ..... | Washer, Flow, 2.0 GPM |
| 12088 | ..... | Washer, Flow, 2.4 GPM |
| 12089 | ..... | Washer, Flow, 3.0 GPM |
| 12090 | ..... | Washer, Flow, 3.5 GPM |
| 12091 | ..... | Washer, Flow, 4.0 GPM |
| 19147 | ..... | Washer, Flow, 4.5 GPM |
| 12092 | ..... | Washer, Flow, 5.0 GPM |
| 17814 | ..... | Washer, Flow, 6.0 GPM |
| 12408 | ..... | Washer, Flow, 7.0 GPM |

### DLFC

|           |       |                           |
|-----------|-------|---------------------------|
| 60705-00  | ..... | DLFC, Plastic, Blank      |
| 60706-8.0 | ..... | DLFC, QC x 3/4"F, 8.0 GPM |
| 60706-9.0 | ..... | DLFC, QC x 3/4"F, 9.0 GPM |
| 60706-10  | ..... | DLFC, QC x 3/4"F, 10 GPM  |
| 60706-12  | ..... | DLFC, QC x 3/4"F, 12 GPM  |
| 60706-15  | ..... | DLFC, QC x 3/4"F, 15 GPM  |

### Power Supplies

|       |       |                                   |
|-------|-------|-----------------------------------|
| 44161 | ..... | Power Supply, US, 12V DC 3M, 2A   |
| 44162 | ..... | Power Supply, INTL, 12V DC 3M, 2A |

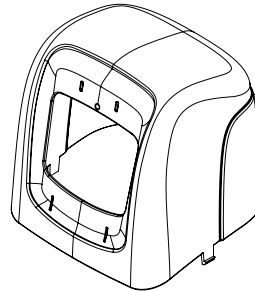

COVER

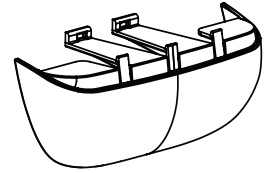

COVER, LOWER

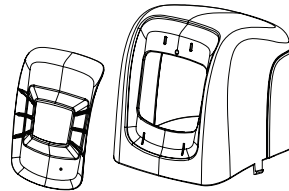

COVER, ENVIRONMENTAL

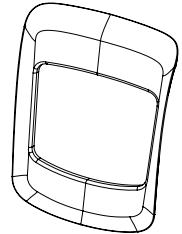

BEZEL

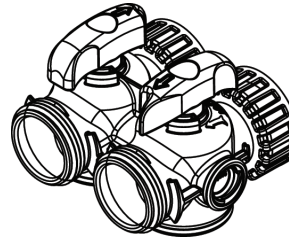

BYPASSES

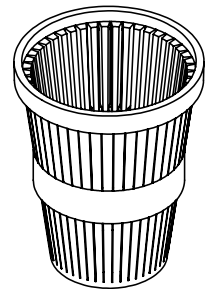

COLLECTORS

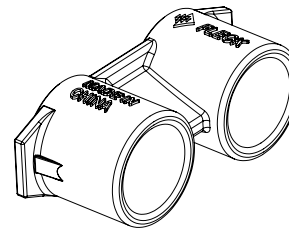

YOKES

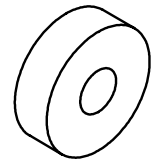

WASHERS

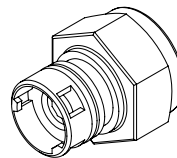

DLFC

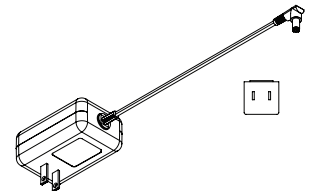

POWER SUPPLIES

## 5800 VALVE ASSEMBLIES

### BLFC

|           |       |                                      |
|-----------|-------|--------------------------------------|
| 60022-12  | ..... | BLFC, 0.125 GPM (0.375 lbs NaCl/min) |
| 60022-25  | ..... | BLFC, 0.25 GPM (0.75 lbs NaCl/min)   |
| 60022-50  | ..... | BLFC, 0.50 GPM (1.5 lbs NaCl/min)    |
| 60022-100 | ..... | BLFC, 1.0 GPM (3 lbs NaCl/min)       |

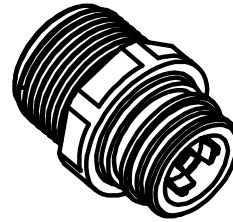

BLFC (3/8")

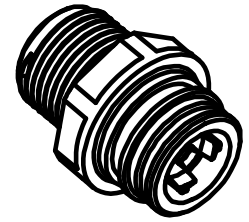

BLFC (1/2")

### Injector Assemblies

|           |       |  |
|-----------|-------|--|
| 18272-000 | ..... | Injector Assy, 1610, #000, BROWN (8" Tank)       |
| 18272-00  | ..... | Injector Assy, 1610, #00, VIOLET (9" & 10" Tank) |
| 18272-0   | ..... | Injector Assy, 1610, #0, RED (12" & 13" Tank)    |
| 18272-1   | ..... | Injector Assy, 1610, #1, WHITE (14" & 16" Tank)  |
| 18272-2   | ..... | Injector Assy, 1610, #2, BLUE (18" Tank)         |
| 18272-3   | ..... | Injector Assy, 1610, #3, YELLOW (20" Tank)       |

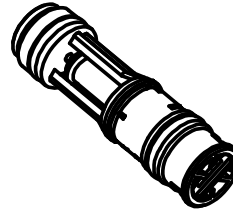

INJECTOR ASSY

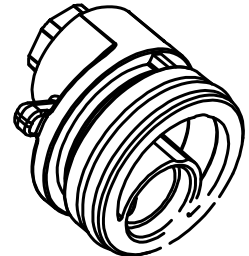

CAP, REGULATED INJECTOR

### Injector Caps

|          |       |  |
|----------|-------|--|
| 18278-20 | ..... | Injector Cap Assy, 1610 Regulated, 5800, 20 PSI, Black |
| 18278-30 | ..... | Injector Cap Assy, 1610 Regulated, 5800, 30 PSI, Gray  |

### Powerheads

|       |       |   |
|-------|-------|---|
| 61957 | ..... | 5800/5810/5812 Powerhead. Less Timer, Less Power Supply |
|-------|-------|---|

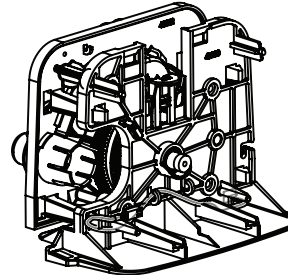

POWERHEAD

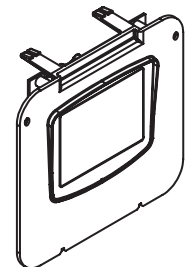

TIMER ASSY, XTR2

### Timers

|          |       |  |
|----------|-------|--|
| 62076    | ..... | Timer Assy, SXT, 5800                                      |
| 61931-03 | ..... | Timer Assy, 5800XTR Touch Scrn w/ Logo, International Lang |
| 62085-01 | ..... | Timer Assy, LXT 5800, Soft TC DF                           |
| 62085-02 | ..... | Timer Assy, LXT 5800, Soft TC UF                           |
| 62085-03 | ..... | Timer Assy, LXT 5800, Soft Mtr DF                          |
| 62085-04 | ..... | Timer Assy, LXT 5800, Soft Mtr UF                          |
| 62085-05 | ..... | Timer Assy, LXT 5800, Fltr Clock                           |
| 62085-06 | ..... | Timer Assy, LXT 5800, Fltr Meter                           |

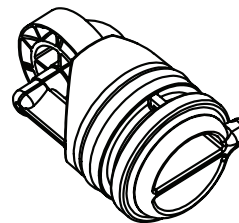

METER ASSY



METER CABLE ASSY

### Meter Assemblies

|          |       |  |
|----------|-------|--|
| 60086-50 | ..... | Meter Assy, 3/4" Dual Port, Slip Elec, Plas, Pdl, w Clips  |
| 60626    | ..... | Meter Assy, Turbine, Electronic 3/4" with Clips and Screws |

### Meter Cables

|          |       |                               |
|----------|-------|-------------------------------|
| 19121-01 | ..... | Meter Cable Assy, SE, Paddle  |
| 19791-01 | ..... | Meter Cable Assy, Turbine/SXT |

### Misc.

|          |       |                                     |
|----------|-------|-------------------------------------|
| 40947-02 | ..... | Plug, Brine Valve, with o-rings     |
| 13918-01 | ..... | BLFC Module Plug Assy, with o-rings |
| 18276-01 | ..... | Injector Assy, Plug, with o-rings   |

## TURBINE METER ASSEMBLY - P/N 60626

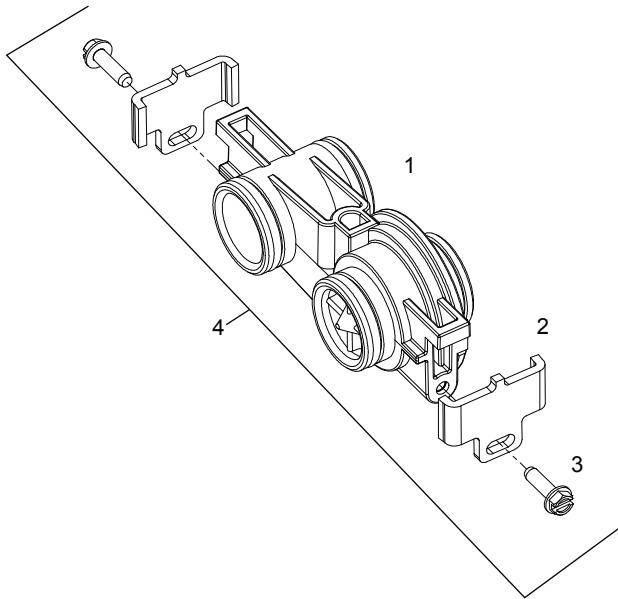

BR60626

| Item No. | QTY    | Part No. | Description   |
|----------|--------|----------|---|
| 1.....   | 1..... | 19797    | Meter Assy, 3/4" Dual Port, SLP   |
| 2.....   | 2..... | 19569    | Clip, Flow Meter  |
| 3.....   | 2..... | 13314    | Screw, Slot Ind Hex, 8-18 x 0.60  |
| 4.....   | 1..... | 60626    | Meter Assy, Turbine, Electronic 3/4" with Clips and Screws (includes 14613 Flow Straightener) |

**Not Shown:**

|       |          |                               |
|-------|----------|-------------------------------|
| ..... | 14613    | Flow Straightener             |
| ..... | 19791-01 | Meter Cable Assy, Turbine/SXT |

## PADDLE METER ASSEMBLY - P/N 60086-50

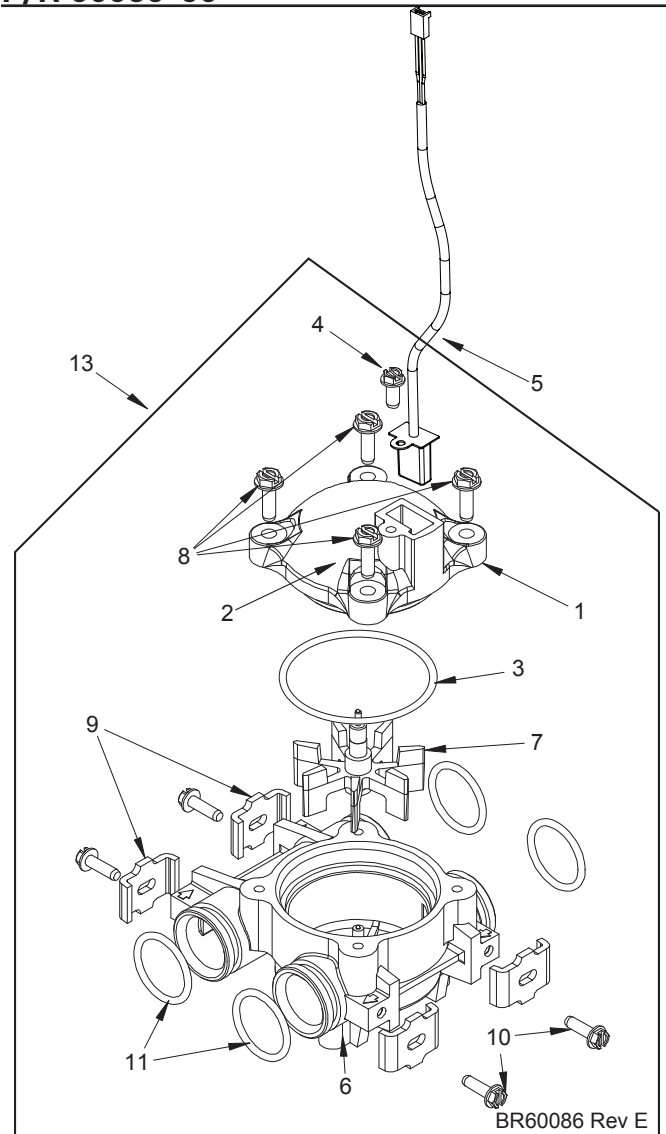

BR60086 Rev E

| Item No. | QTY    | Part No. | Description  |
|----------|--------|----------|--|
| 1.....   | 1..... | 14716    | Meter Cap Assy, NT (includes items 2, 3, and 4)              |
| 2.....   | 1..... | 13874    | Cap, Meter, Electronic                                       |
| 3.....   | 1..... | 13847    | O-ring, -137, Std, Meter                                     |
| 4.....   | 1..... | 17798    | Screw, Slot Hex Washer Head                                  |
| 5.....   | 1..... | 19121-01 | Meter Cable Assy, SXT, Paddle (not included in P/N 60086-50) |
| 6.....   | 1..... | 13821    | Body, Meter, 5600  |
| 7.....   | 1..... | 13509    | Impeller, Meter  |
| 8.....   | 4..... | 12473    | Screw, Hex Wsh, 10-24 x 5/8                                  |
| 9.....   | 4..... | 13255    | Clip, Mounting   |
| 10.....  | 4..... | 13314    | Screw, Slot Ind Hex, 8-18 x 0.60                             |
| 11.....  | 4..... | 13305    | O-ring, -119   |
| 12.....  | 1..... | 14613    | Flow Straightener  |
| 13.....  | 1..... | 60086-50 | Meter Assy, 3/4" Dual Port, Slip                             |



## BYPASS VALVE ASSEMBLY (METAL)

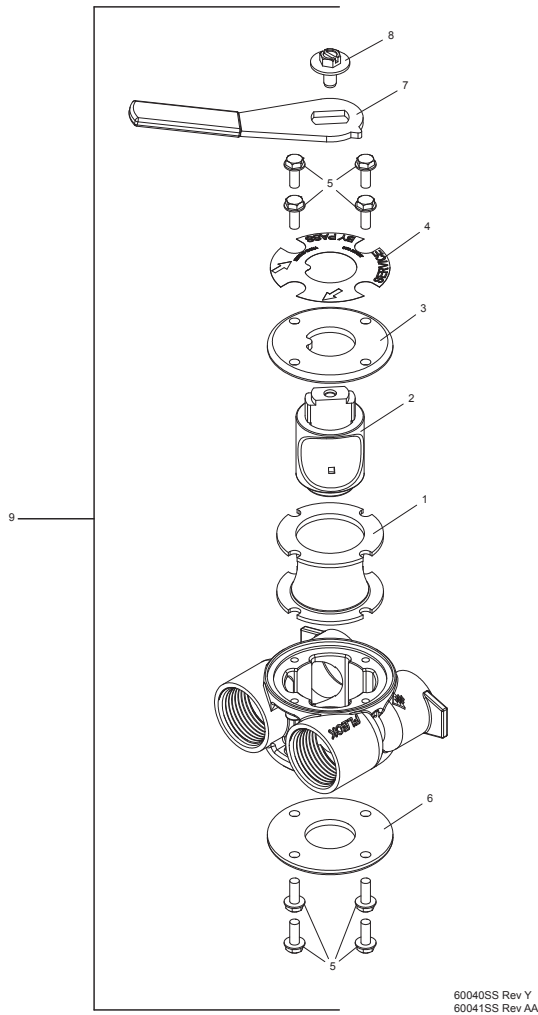

| Item No. | QTY | Part No. | Description  |
|----------|-----|----------|--|
| 1        | 1   | 14105    | Seal, Bypass, 560CD  |
| 2        | 1   | 11972    | Plug, Bypass   |
| 3        | 1   | 11978    | Side Cover   |
| 4        | 1   | 13604-01 | Label  |
| 5        | 8   | 15727    | Screw, 10-24 x 0.5"  |
| 6        | 1   | 11986    | Side Cover   |
| 7        | 1   | 11979    | Lever, Bypass  |
| 8        | 1   | 11989    | Screw, Hex Head, 1/4-14 x 1.5"                               |
| 9        | 1   | 60040SS  | Bypass Valve, 5600, 3/4" NPT Black Grip Lever, SS            |
|          |     | 60041SS  | Bypass Valve, 5600, 1" NPT Black Grip Lever, Stainless Steel |

**Not Shown:**

|   |   |          |                                   |
|---|---|----------|-----------------------------------|
| 2 | 1 | 19228-01 | Adapter Assy, Coupling, w/O-rings |
|---|---|----------|-----------------------------------|

## BYPASS VALVE ASSEMBLY (PLASTIC)

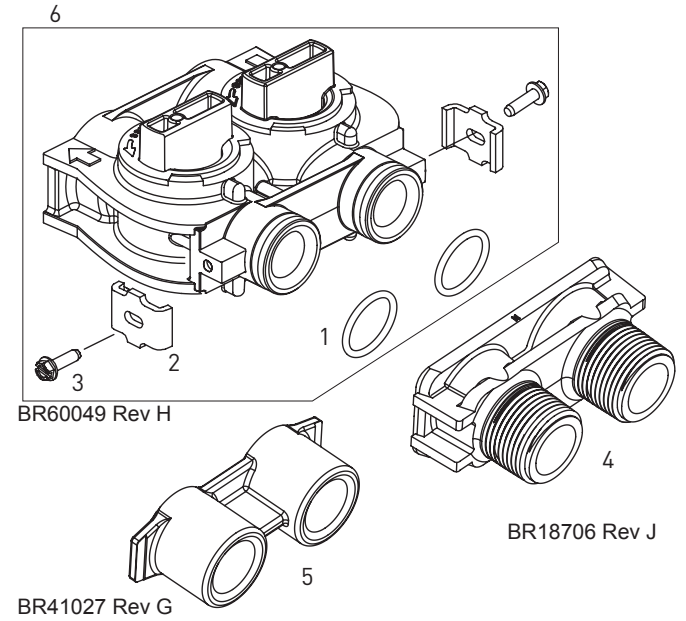

| Item No. | QTY | Part No. | Description   |
|----------|-----|----------|---|
| 1        | 2   | 13305    | O-ring, -119  |
| 2        | 2   | 13255    | Clip, Mounting  |
| 3        | 2   | 13314    | Screw, Slot Ind Hex, 8-18 x 0.60                            |
| 4        | 1   | 18706    | Yoke, 1", NPT, Plastic                                      |
|          |     | 18706-02 | Yoke, 3/4", NPT, Plastic                                    |
| 5        | 1   | 13708-40 | Yoke, 1", Sweat   |
|          |     | 13708-45 | Yoke, 3/4", Sweat   |
|          |     | 19275    | Yoke, Angle 90 Deg, 3/4", NPT                               |
|          |     | 19275-45 | Yoke, Angle 90 Deg, 3/4", Sweat                             |
|          |     | 19620-01 | Yoke, Assy, 3/4", R/Angle 90 Deg, w/O-rings, Clips & Screws |
|          |     | 40636    | Yoke, 1-1/4", NPT   |
|          |     | 40636-49 | Yoke, 1-1/4", Sweat   |
|          |     | 41027-01 | Yoke, 3/4", NPT, Cast, Machined                             |
|          |     | 41026-01 | Yoke, 1", NPT, Cast, Machined, SS                           |
|          |     | 41026-02 | Yoke, 1", BSP, Cast, Machined, SS                           |
|          |     | 18706-10 | Yoke, 1", BSP, Plastic                                      |
|          |     | 41027-02 | Yoke, 3/4", BSP, Cast, Machined                             |
|          |     | 18706-12 | Yoke, 3/4", BSP, Plastic                                    |
|          |     | 19620-01 | Yoke Assy, 3/4", R/Angle, 90 Deg                            |
| 6        | 1   | 60049    | Bypass Plastic  |

**Not Shown:**

|   |   |          |                                   |
|---|---|----------|-----------------------------------|
| 2 | 1 | 19228-01 | Adapter Assy, Coupling, w/O-rings |
|---|---|----------|-----------------------------------|

# SAFETY BRINE VALVE

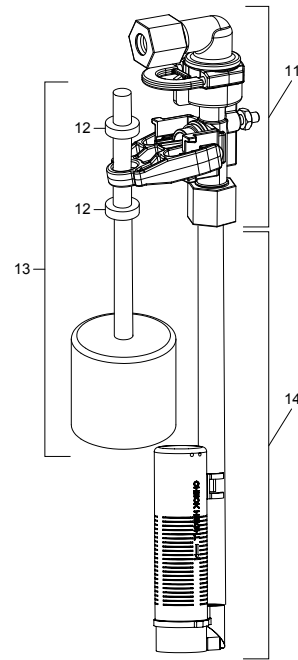
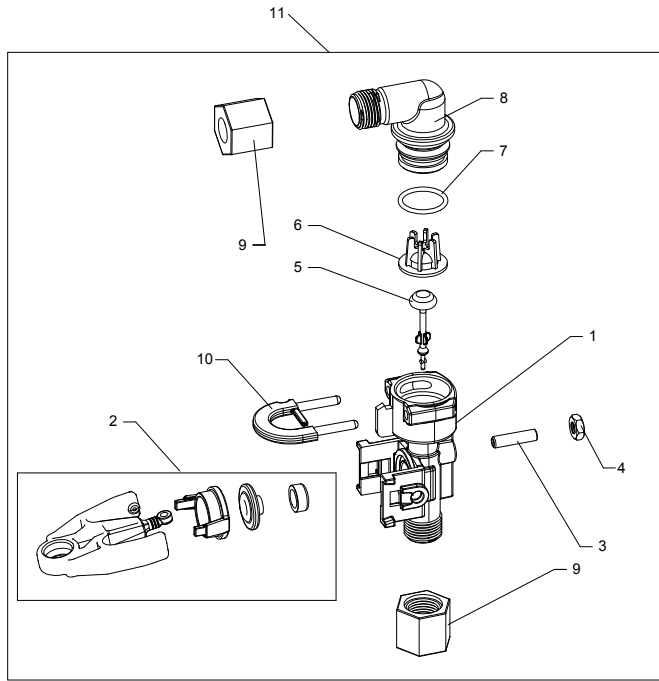

42112 Rev A

| Item No. | QTY | Part No.    | Description                       |
|----------|-----|-------------|-----------------------------------|
| 1        | 1   | 19645       | Body, Safety Brine Valve, 2310    |
| 2        | 1   | 19803       | Safety Brine Valve Arm Assy       |
| 3        | 1   | 19804       | Screw, Sckt Hd, Set, 10-24 x 0.75 |
| 4        | 1   | 19805       | Nut, Hex, 10-24, Nylon Black      |
| 5        | 1   | 19652-01    | Poppet Assy, SBV w/O-ring         |
| 6        | 1   | 19649       | Flow Disperser                    |
| 7        | 1   | 11183       | O-ring, -017                      |
| 8        | 1   | 19647       | Elbow, Safety Brine Valve         |
| 9        | 2   | 19625       | Nut Assy, 3/8" Plastic            |
| 10       | 1   | 18312       | Retainer, Drain                   |
| 11       | 1   | 60014       | Safety Brine Valve Assy, 2310     |
| 12       | 2   | 10150       | Grommet, 0.30 Dia                 |
| 13       | 1   | 60068-30    | Float Assy, 2310, w/30" Rod       |
| 14       | 1   | 60002-11.38 | Air Check, #500, 11.38" Long      |
|          |     | 60002-27    | Air Check, #500, 27" Long         |
|          |     | 60002-32    | Air Check, #500, 32" Long         |
|          |     | 60002-34    | Air Check, #500, 34" Long         |
|          |     | 60002-36    | Air Check, #500, 36" Long         |
|          |     | 60002-48    | Air Check, #500, 48" Long         |

# WATER CONDITIONER FLOW DIAGRAMS

## Upflow

1. Service Position

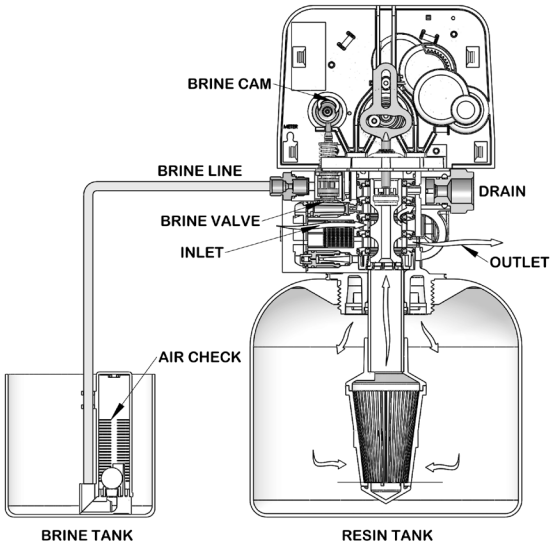

2. Brine/Slow Rinse Position

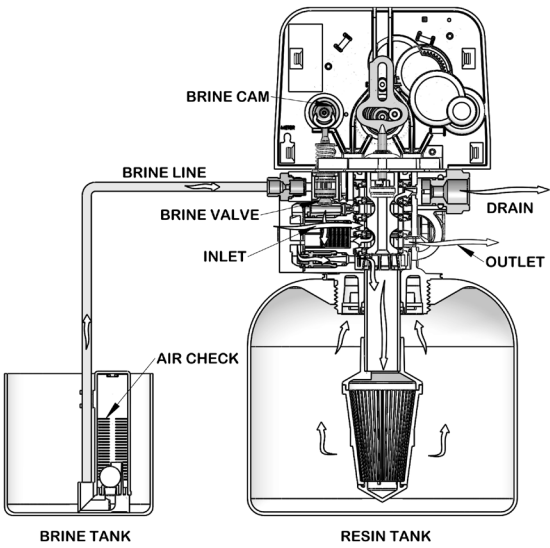

3. Backwash Position

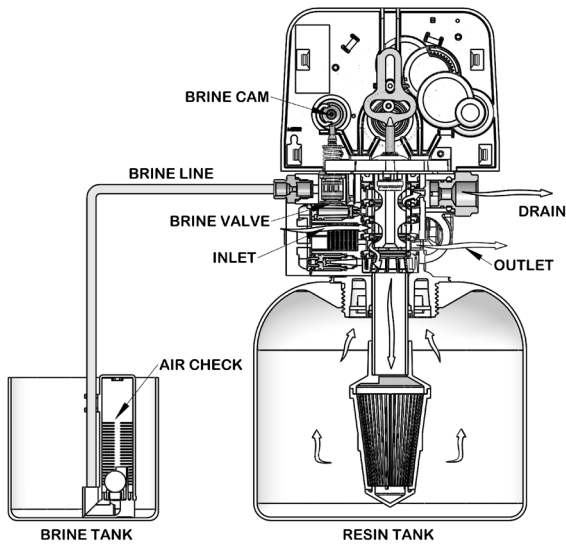

4. Rapid Rinse Position

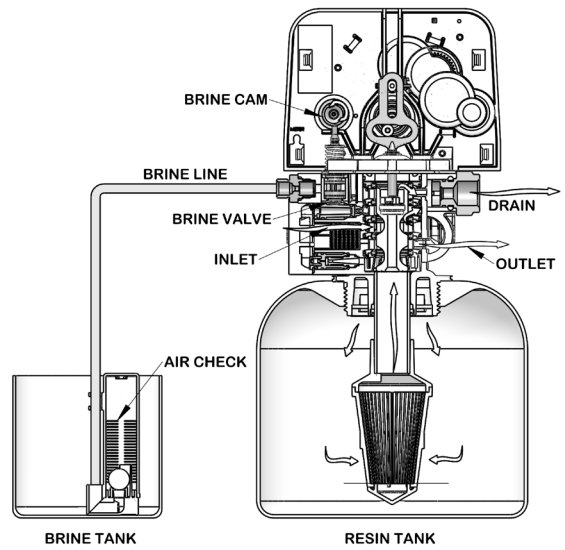

5. Brine Tank Refill Position

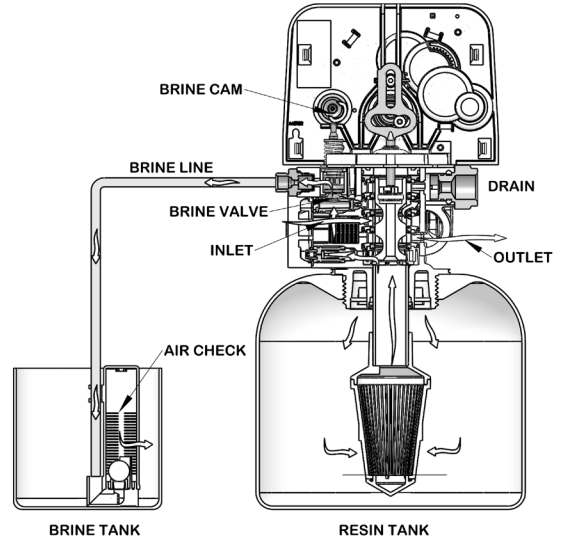

# WATER CONDITIONER FLOW DIAGRAMS

*continued*

## Downflow

### 1. Service Position

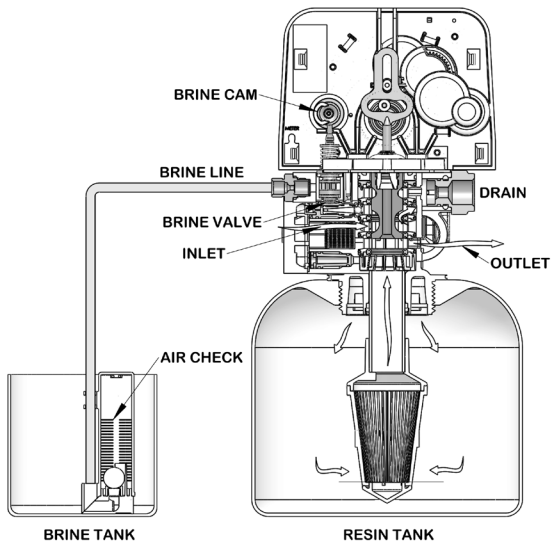

### 2. Backwash Position

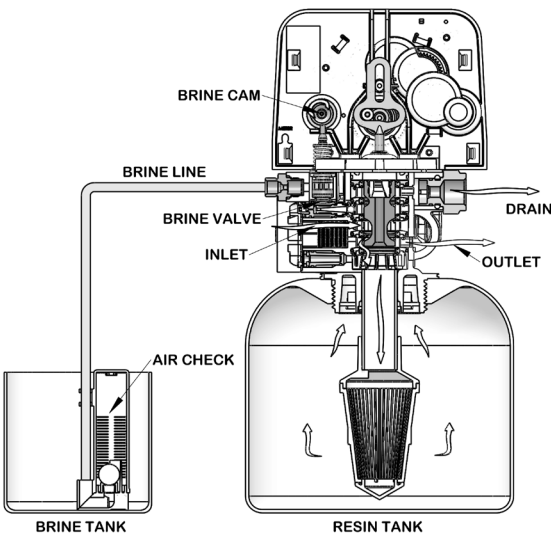

### 3. Brine/Slow Rinse Position

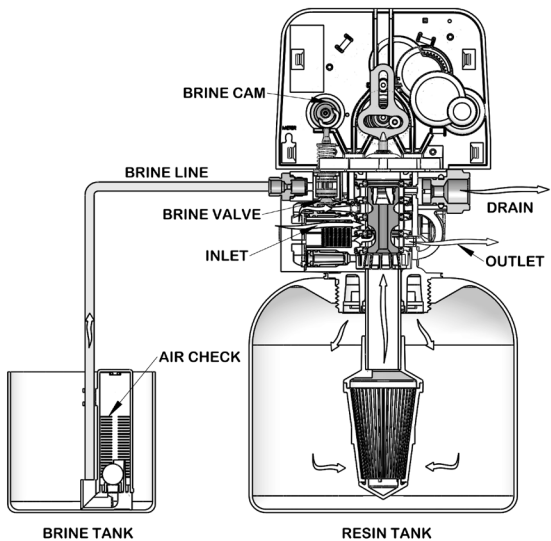

### 4. Rapid Rinse Position

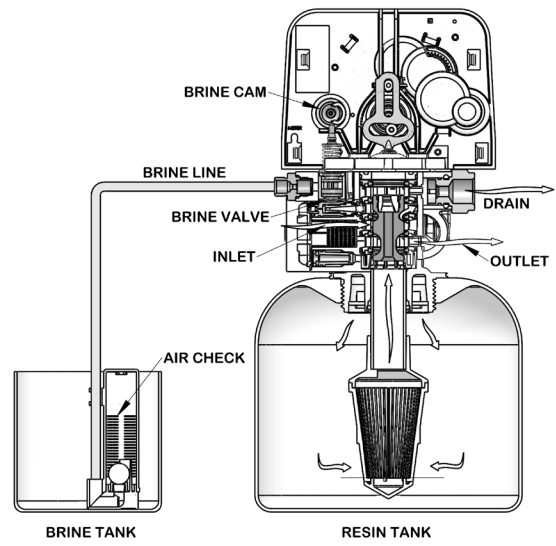

### 5. Brine Tank Refill Position

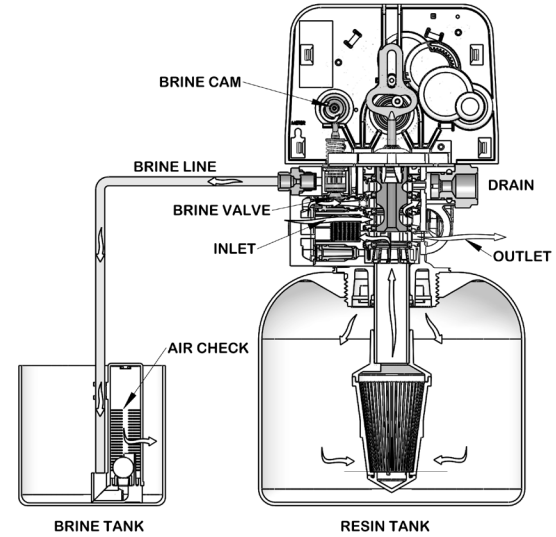

# DIMENSIONAL DRAWINGS

Measurements  
[ mm ]  
[ inches ]

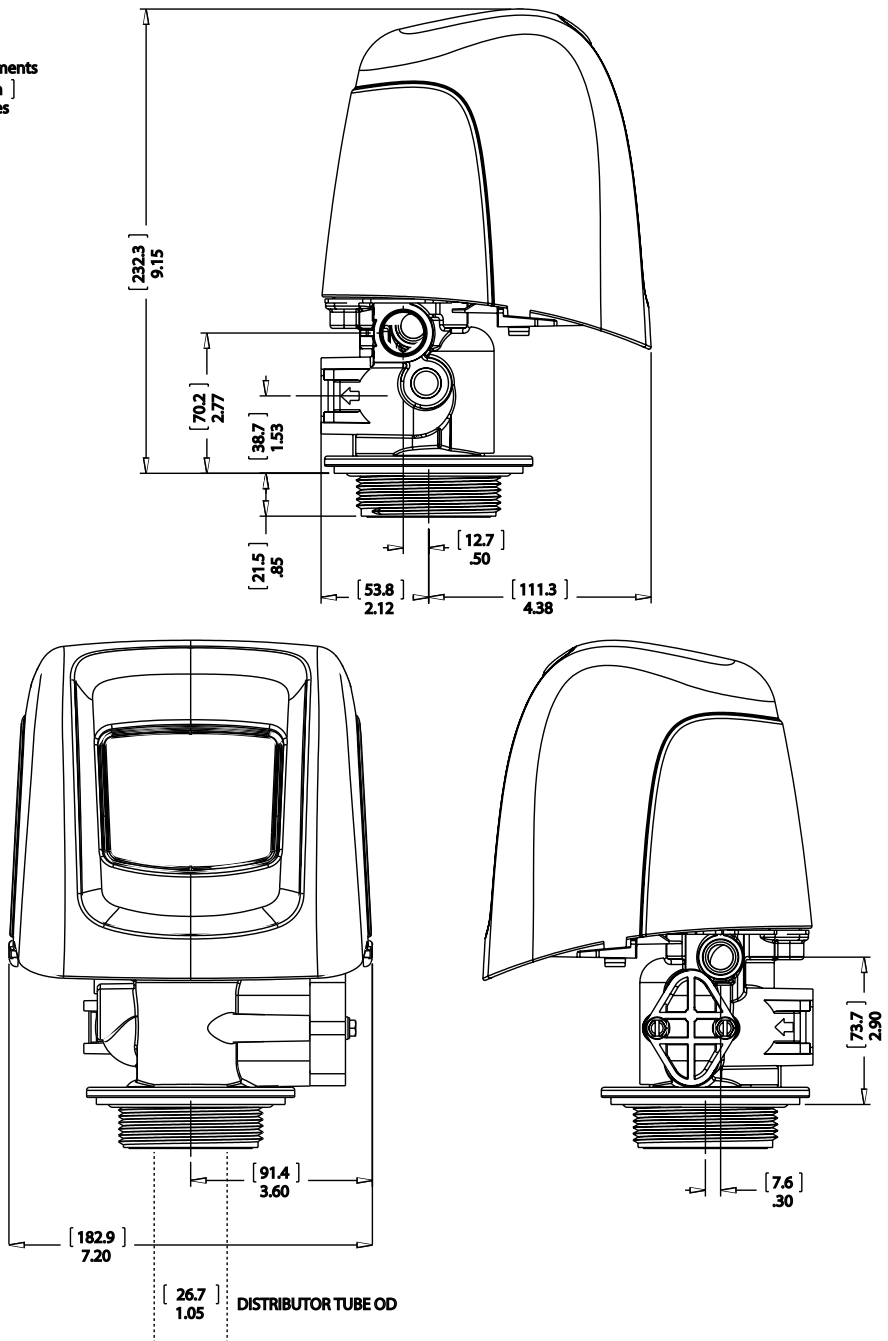

BR61500-5800LNE Rev A

## TRANSFORMER PORT LOCATION

5800/5810/5812 Transformer port location (plugging in transformer)  
When looking at valve from front, reach around back under cover on right hand side.  
Transformer port is located just past the cover's snap feature.

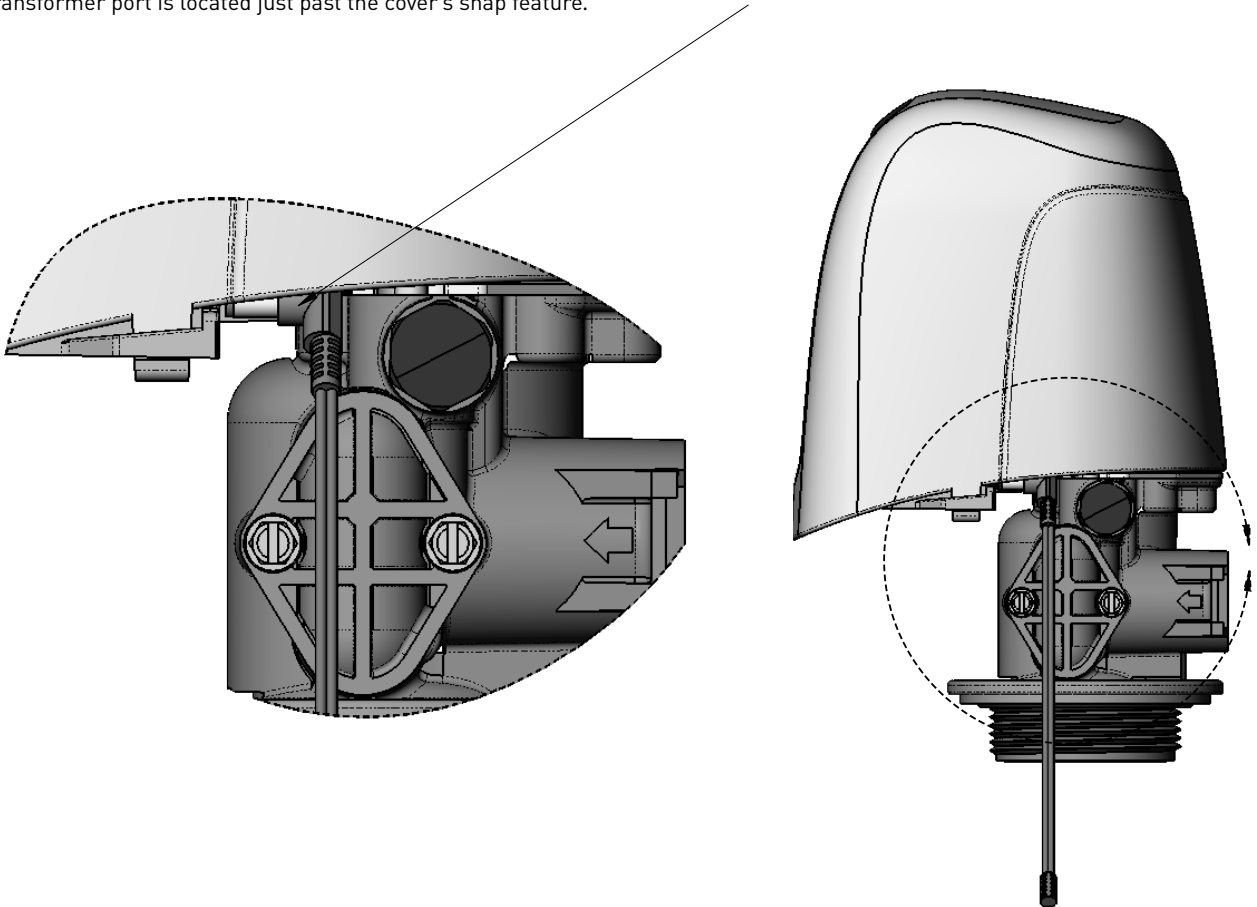

44288 REV A

# INJECTOR FLOW DATA

**Injector #000**

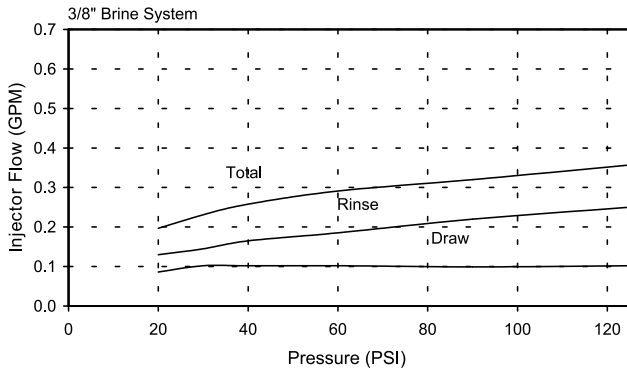

**Injector #00**

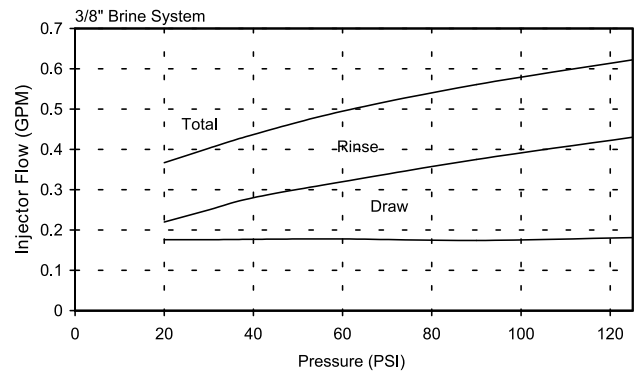

**Injector #0**

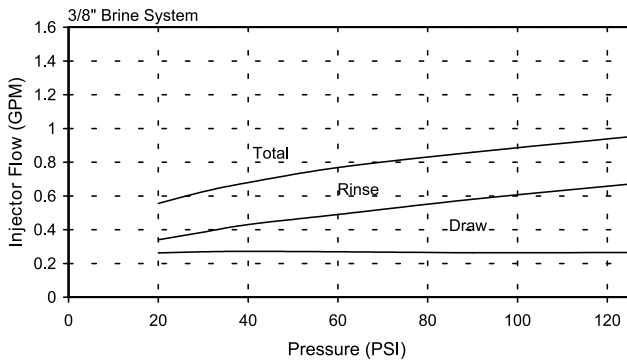

**Injector #1**

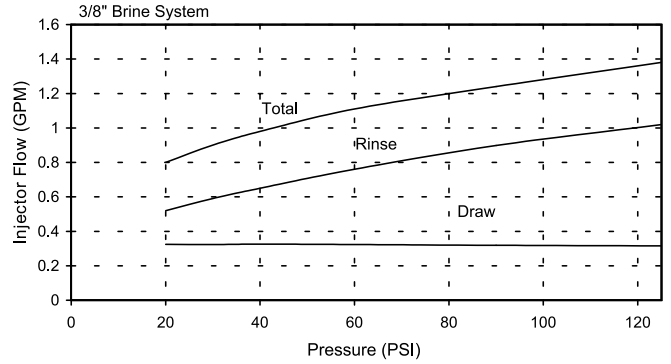

**Injector #2**

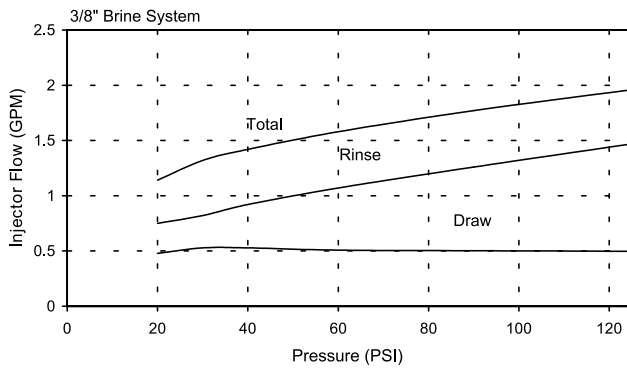

**Injector #3**

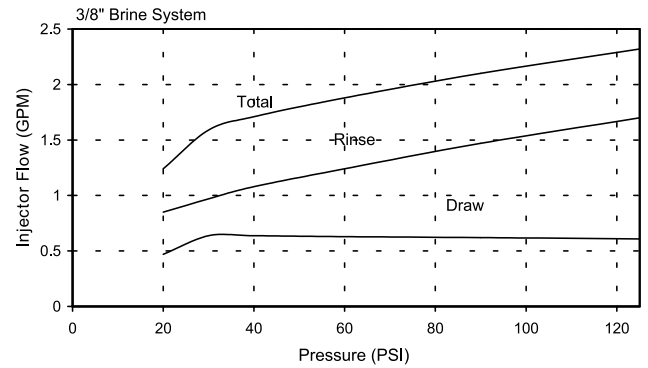

TR18755 Rev B

# WIRING DIAGRAM

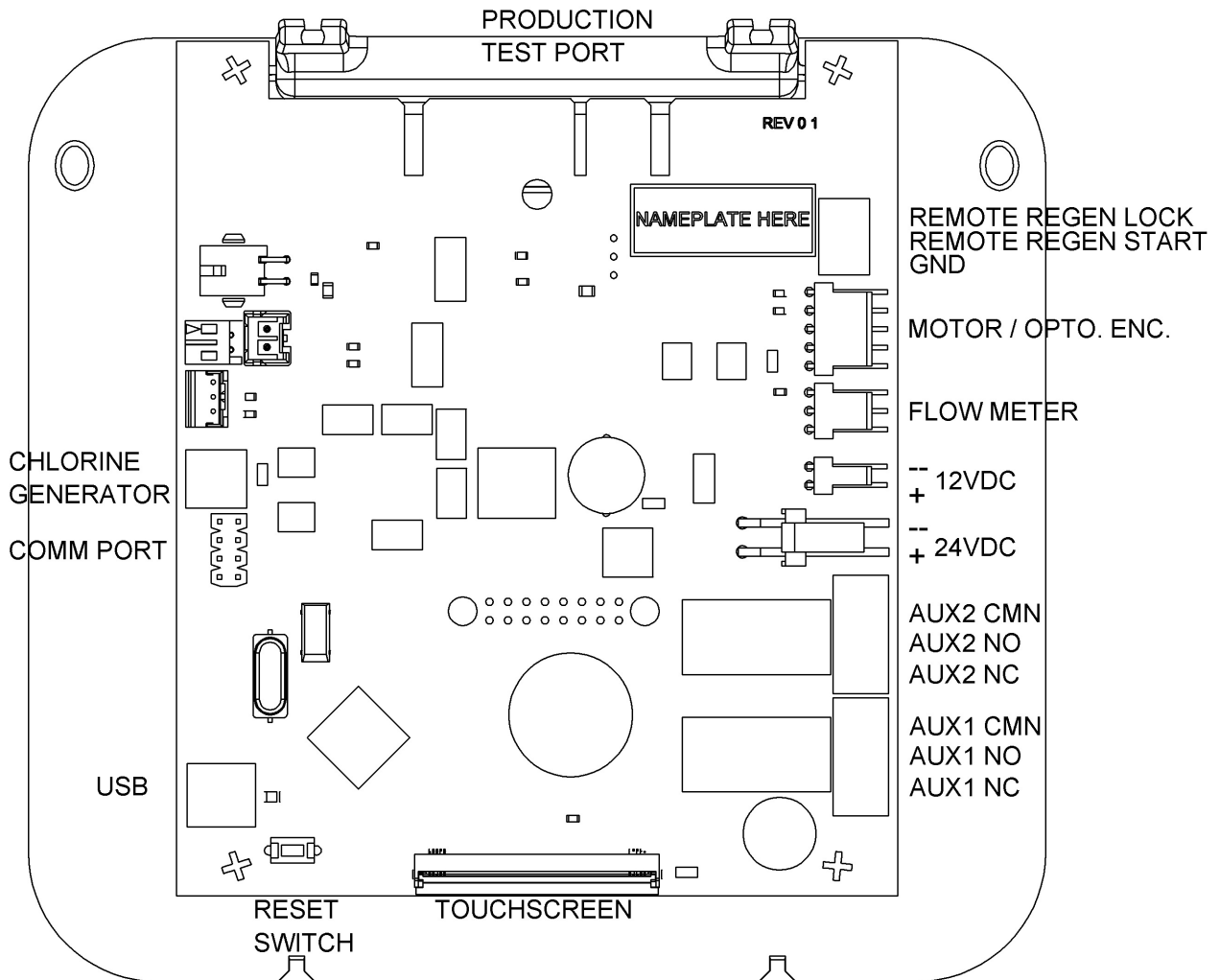

**NOTE:** The reset switch discharges the super capacitor when power is removed from the control. The super capacitor retains the current time of day in the event of a power failure. Pressing the reset switch on the circuit board while power is applied to the control will have no effect on the control or stored settings.

44218 Rev A

Chlorine Generator can only be used with +12VDC power supply (international version only).

+12VDC power supply with 5800, 5810, 5812 valves only.









For Pentair Fleck Product Warranties visit: [waterpurification.pentair.com](https://waterpurification.pentair.com)



13845 Bishops Dr. | Suite 200 | Brookfield, WI 53005 | United States  
P: 262.238.4400 | Customer Service: 800.279.9404 | [tech-support@pentair.com](mailto:tech-support@pentair.com) | [pentair.com](https://pentair.com)

All indicated Pentair trademarks and logos are property of Pentair. Third party registered and unregistered trademarks and logos are the property of their respective owners.  
© 2022 Pentair. All rights reserved.

43359-02 REV J DE22



\*43359-02\*